

**Product Code:**

MMF/100

Product Range:Cable Tray, Pre Galvanised,
Medium Duty**Issue Date:**

7/5/2026

Description:

100mm Medium Duty Cable Tray (3m Length)

Features:

- 25mm Return Flange.
- All Medium Duty cable tray supplied as 3 metre lengths up to 600mm wide.
- Available in 3 standard designs of cable tray to suit individual applications.
- Distinctive hole pattern designed to provide maximum flexibility for the installer without compromising strength.
- Manufactured from zinc coated galvanised steel to BS EN 10346:2015.
- Special sizes and bespoke designs are available upon request.
- Lid for cable tray available upon request.
- Solid (plain) cable tray available upon request.
- Can be powder coated to customer specific RAL colour.

**Technical:****Product Type** Cable Tray**Width** 100mm**Height** 25mm**Length** 3000mm**Weight** 3.15 Kgs**Gauge** Medium Duty**Material** Pre-Galvanised Steel (Zinc Coated)**Colour/Finish** Self Colour**Standards** BS EN 61537:2007; BS EN 10346:2015

The approximate weights given are for pre-galvanised finish only, in kilograms (nominal) and subject to material thickness tolerance.

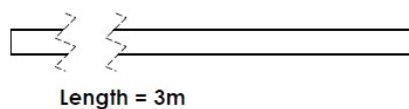
Dimensions

Length = 3m

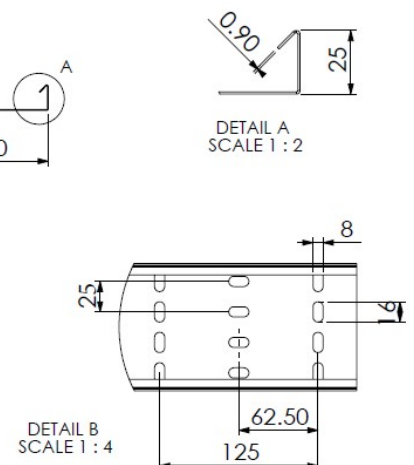
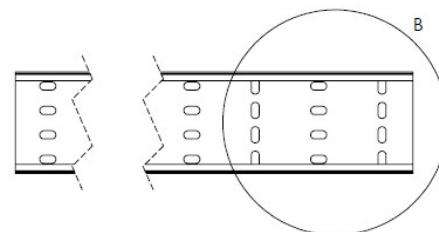
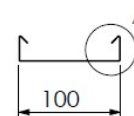

Tamlex | Harcourt | Halesfield 15 | Telford | Shropshire | TF7 4ER

T: 01952 586689 E: sales@tamlex.co.uk W: www.tamlex.co.uk