

**Product Code:**

TRC43-32

Product Range:

Cable Trunking, Turnbuckle Accessories

Issue Date:

1/5/2026

**Description:**

100x75mm To 75x50mm Turnbuckle Reducer

Features:

- Tamlex offers a comprehensive range of trunking accessories.
- All reducers are supplied with built-in threaded couplers to allow them to be fitted directly to the trunking using an M6 screw.
- All lids are secured using a turnbuckle fixing.
- Multi Compartment trunking and accessories available.
- Special sizes and bespoke designs are available upon request.
- Tamperproof lid fixing option available on request.
- Can be powder coated to customer specific RAL colour.
- IP4X Cover straps are only required for Length to Length joins. (Sold Separately).

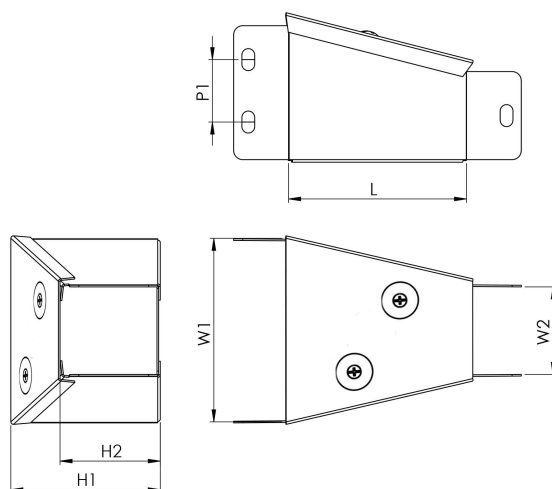

Image for illustrative purposes only

Technical:**Product Type** Reducer**Width** Reduce 100mm x 75mm**Height** To 75mm x 50mm**Weight** 0.29 Kgs**Number of Compartments****Material** Pre-Galvanised Steel (Zinc Coated)**Colour/Finish** Self Colour**Standards** BS EN 50085-2-1 2006; BS EN 10346:2015**Trunking Weights:**

1. Compartment	2. Compartment	3. Compartment
0.29 Kgs		

The approximate weights given are for pre-galvanised finish only, in kilograms (nominal) and subject to material thickness tolerance.

Dimensions: (mm)**P1** 35mm**Important:**

Tamlex cable trunking is designed with strength and durability in mind, trunking must be installed so that the lid does not bear any cable weight. Incorrect installation may affect the integrity of the system and is not recommended., with the main body engineered to support the weight of installed cables. To ensure optimal performance and safety