

**Product Code:**

BP6

Product Range:Cable Trunking, Trunking
Accessories**Issue Date:**

6/4/2026

Description:

150mm Bridge Pieces for Steel Trunking (Pack 4)

Features:

- 150mm bridge piece packs for Tamlex trunking are specially designed to secure and fit trunking lids/covers.
- Supplied with sleeve couplers and M6 Screws to join lengths of trunking together.
- Bridge pieces also act as cable retainers to secure cables in trunking when lid/cover removed.

**Technical:****Product Type** Bridge Piece**Width** 150mm**Material** Pre-Galvanised Steel (Zinc Coated)**Colour/Finish** Self Colour**Standards** BS EN 50085-2-1 2006; BS EN 10346:2015**Pack Quantity** Supplied in pairs

The approximate weights given are for pre-galvanised finish only, in kilograms (nominal) and subject to material thickness tolerance.

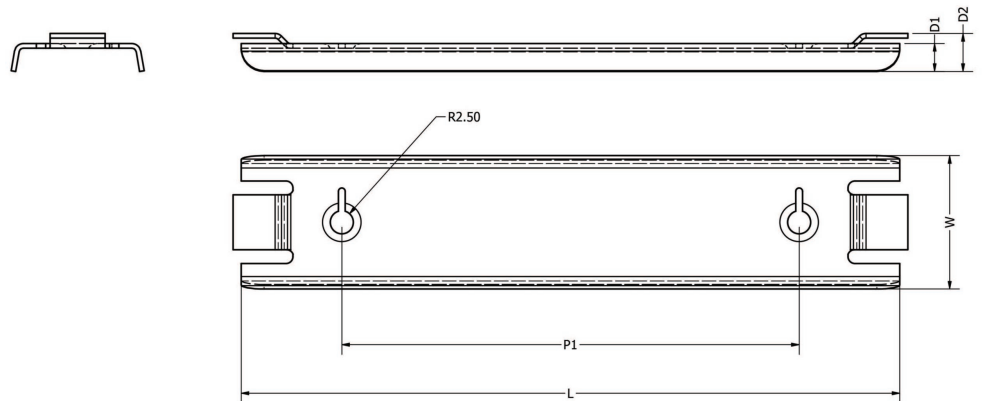

Tamlex | Harcourt | Halesfield 15 | Telford | Shropshire | TF7 4ER

T: 01952 586689 **E:** sales@tamlex.co.uk **W:** www.tamlex.co.uk