

**Product Code:**

TGTN32

Product Range:

Gusset Tee Inside Lid, Cable Trunking, Turnbuckle Accessories

Issue Date:

8/4/2026

**Description:**

75mm x50mm IP4X Turnbuckle Gusset Tee Inside Lid

Features:

- Tamlex offers a comprehensive range of gusset bends and tees which allow a greater bend radius for cables.
- Integrated IP4X compliance as standard - no need to order additional components.
- All bends are supplied with built-in threaded couplers to allow them to be fitted directly to the trunking using an M6 screw.
- All lids are secured using a turnbuckle fixing.
- Multi Compartment trunking and accessories available.
- Special sizes and bespoke designs are available upon request.
- Tamperproof lid fixing option available on request.
- Can be powder coated to customer specific RAL colour.

**IMAGE FOR ILLUSTRATIVE PURPOSES ONLY****Technical:****Product Type** Gusset Tee**Width** 75mm**Height** 50mm**Weight** 0.55 Kgs**Number of Compartments****Material** Pre-Galvanised Steel (Zinc Coated)**Colour/Finish** Self Colour**Standards** BS EN 50085-2-1 2006; BS EN 10346:2015**Trunking Weights:**

1. Compartment	2. Compartment	3. Compartment
0.55 Kgs		

The approximate weights given are for pre-galvanised finish only, in kilograms (nominal) and subject to material thickness tolerance.

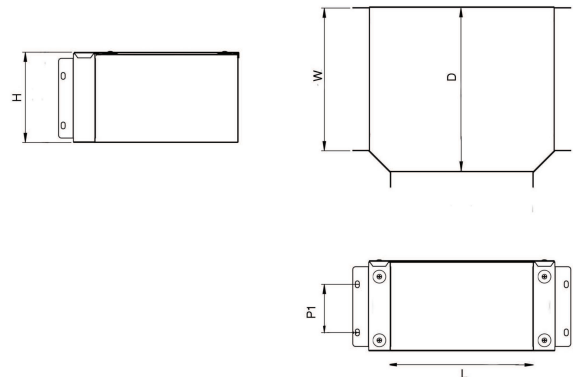
Dimensions: (mm)**H** 73mm**W** 52mm**L** 48mm**P1** N/A**Important:**

Tamlex cable trunking is designed with strength and durability in mind, trunking must be installed so that the lid does not bear any cable weight. Incorrect installation may affect the integrity of the system and is not recommended., with the main body engineered to support the weight of installed cables. To ensure optimal performance and safety