

**Product Code:**

RC33-32

Product Range:Cable Trunking, Standard
Trunking Accessories**Issue Date:**

26/6/2026

Description:

75x75mm To 75x50mm Reducer

Features:

- Tamlex offers a comprehensive range of trunking accessories.
- All reducers are supplied with built-in threaded couplers to allow them to be fitted directly to the trunking using an M6 screw.
- All lids are secured using 'Bridge Pieces'.
- Multi Compartment trunking and accessories available.
- Special sizes and bespoke designs are available upon request.
- Tamperproof lid fixing option available on request.
- Can be powder coated to customer specific RAL colour.
- Manufactured to allow retrofit installation of our IP4X system. (Sold Separately).



Image for illustrative purposes only

Technical:**Product Type** Reducer**Width** Reduce 75mm x 75mm**Height** To 75mm x 50mm**Number of Compartments****Material** Pre-Galvanised Steel (Zinc Coated)**Colour/Finish** Self Colour**Standards** BS EN 50085-2-1 2006; BS EN 10346:2015

The approximate weights given are for pre-galvanised finish only, in kilograms (nominal) and subject to material thickness tolerance.

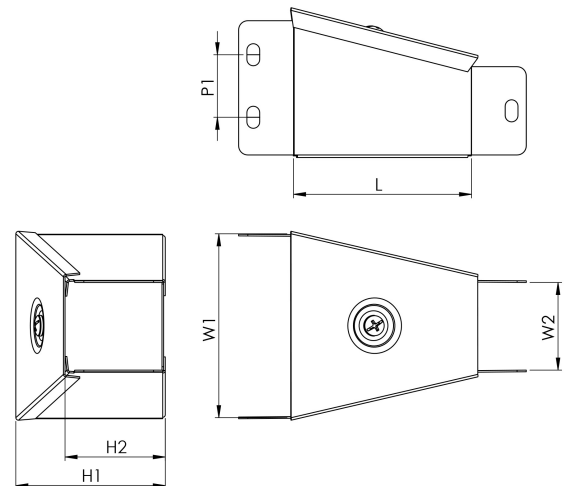

Tamlex | Harcourt | Halesfield 15 | Telford | Shropshire | TF7 4ER

T: 01952 586689 E: sales@tamlex.co.uk W: www.tamlex.co.uk