

**Product Code:**

HDL/900/G

**Product Range:**Heavy Duty Lengths, Ladder  
Rack, Heavy Duty**Issue Date:**

24/6/2026

**Description:**900mm Heavy Duty 125mm Deep Ladder HDG - 3 Metre  
Length**Features:**

- Durable hot dip galvanised finish for long-term corrosion resistance.
- Designed to support high cable loads over long spans.
- Suitable for heavy-duty industrial and commercial applications.
- Wide range of accessories including bends, tees, risers and reducers.
- Compatible with industry-standard fixings and couplers.
- Rung spacing: 300mm between centres.
- Even when ladders are cut to length, the slots in the coupler will always align with the slots in the ladder side rails.
- When connecting fittings to straight lengths, use fastener sets.
- Manufactured to meet UK and international standards.
- Covers for cable ladder available upon request.
- 6 metre lengths available upon request.

**Technical:****Product Type** Ladder Tray**Width** 900mm**Height** 125mm**Length** 3000mm**Weight** 23.90 Kgs**Dimensions** 300mm Rung Pitch**Gauge** 1.5mm**Material** Post Hot-Dipped Galvanised (HDG)**Colour/Finish** Self Colour**Standards** BS EN ISO 1461:2009**Important:**

HDG ladders are suitable for internal and external use, including light industrial and coastal environments. Ensure cut edges or drilled holes are treated with a suitable zinc-rich paint or similar to maintain corrosion protection.

**Extra Information**

3 m and 4 m spans using 3 m lengths. Safe working load should include all cable loads and any other additional loads (e.g. wind, snow).

The approximate weights given are for pre-galvanised finish only, in kilograms (nominal) and subject to material thickness tolerance.

**Dimensions: (mm)****W** 940mm



## HEAVY DUTY DIMENSIONS AND WEIGHTS

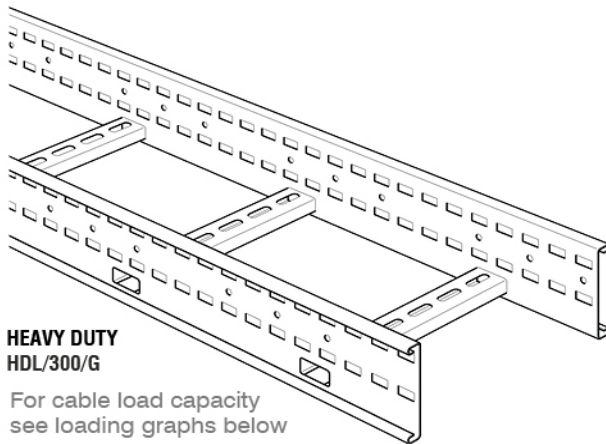

### HEAVY DUTY HDL/300/G

For cable load capacity see loading graphs below

#### GAUGE

Standard side rail = 1.5mm

### WEIGHTS

WIDTH (W)	CAT NO.	WEIGHT (kg)
150	HDL/150/G	13-8
300	HDL/300/G	15-0
450	HDL/450/G	16-3
600	HDL/600/G	18-5
750	HDL/750/G	22-0
900	HDL/900/G	23-9

All weights given are for a 3m straight length in hot dip galvanised finish.

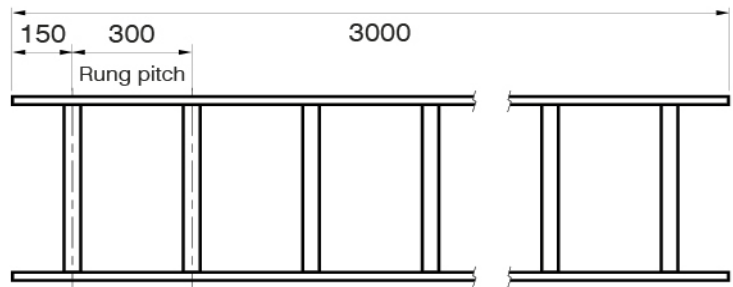
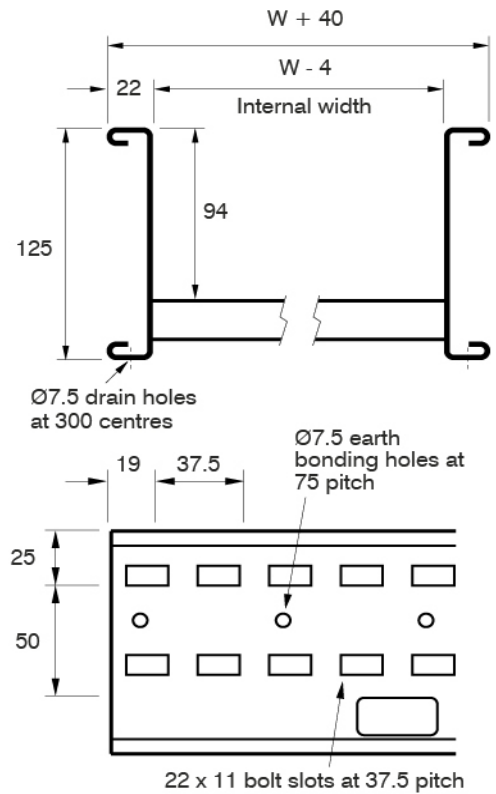

## LOADING GRAPHS

- Load tests carried out to BS EN 61537 test type 1 (safety factor 1.7+ and joint in middle of span) or test type 4 (safety factor 1.7+ and joint in middle of span with rung slot over support).
- Load tests carried out over 3 m, 4 m and 5 m spans using 3 m lengths and 6 m spans using 6 m lengths.
- Safe working load should include all cable loads (kg/m) and any other additional loads (e.g. wind, snow).
- For spans greater than 5 m : data is for 6 m long ladders only. For spans 5 m and less : data can be used for 3 m or 6 m long lengths.
- For spans greater than 5 m : ladder is not suitable for use with dynamic loads (e.g. wind, snow).
- When installed, inner span deflection will vary depending on joint positions but will typically be about half of test end span deflection shown below.



**SHEARED STEEL DOES HAVE RELATIVELY SHARP EDGES AND PROTECTIVE GLOVES MUST BE WORN DURING HANDLING**

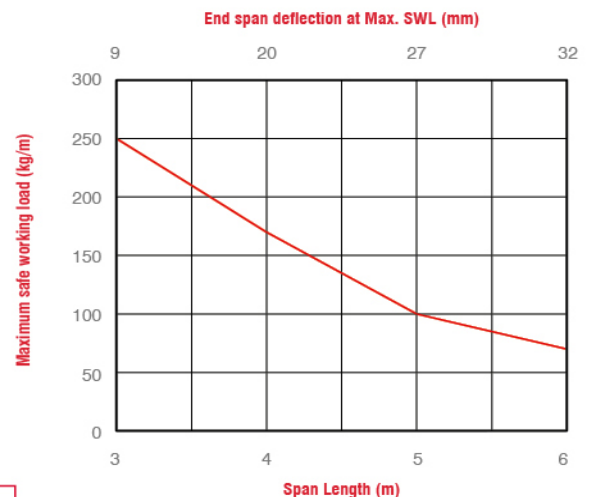

Graph showing safe working load vs span with deflections shown at SWL