

Product Data Sheet



Product Code:	Issue No.	Issue Date:	Issue by:
TC103-75	A	03.10.09	D.B.P

Description

Light Duty Cantilever Arm Support - 750mm

Features

Brackets are designed to comply with BS6946

Manufactured from 6mm thick steel

Special Finish: All channel brackets are post hot dipped galvanised to BS729

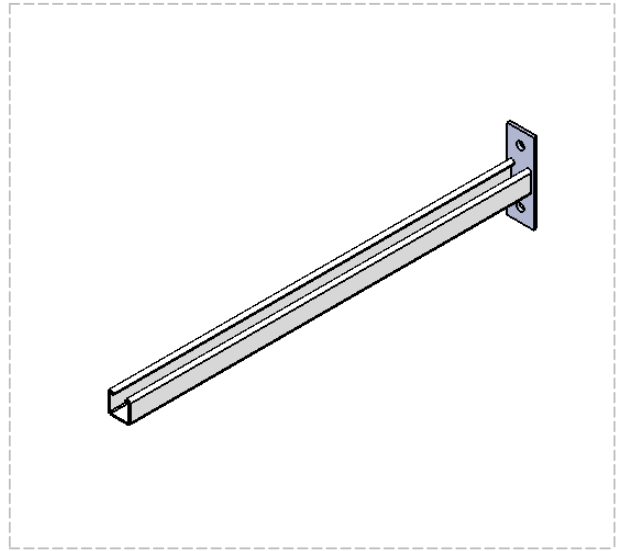

General Characteristics

Material	Low carbon steel strip (BSEN10142:2000)
Finish	Hot Dipped Zinc
Cantilever Arm	41 x 41mm strut 2.5mm channel
Cantilever length	750mm
Suitable for Tray width	600mm

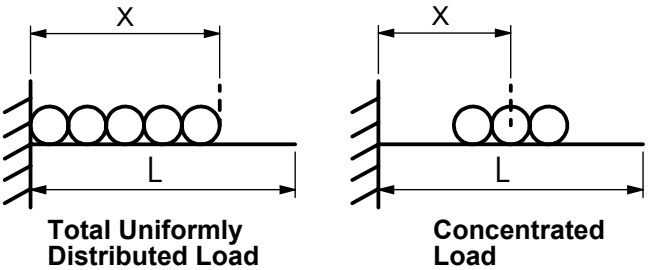

Dimensions

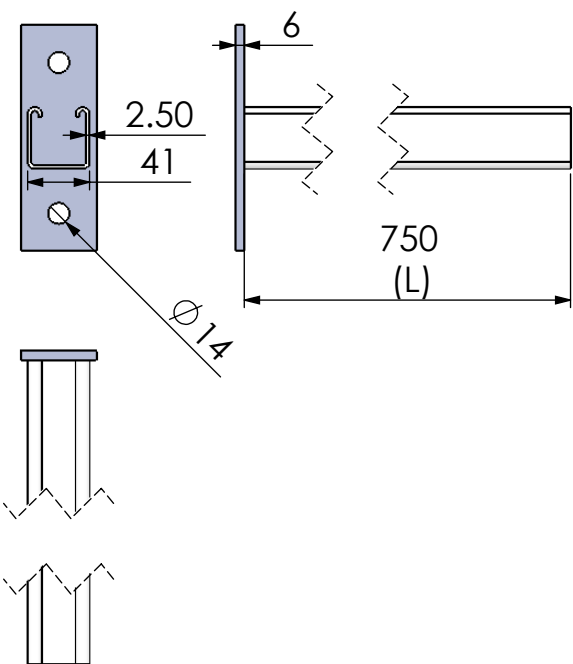

Recommended Safe Loads (kg)

x (m)	Total Uniformly Distributed Load (kg)	Concentrated Load (kg)
0.10	684	342
0.15	608	342
0.20	542	283
0.25	452	226
0.30	377	188
0.35	323	162
0.40	283	141
0.45	251	126
0.50	226	113
0.55	206	103
0.60	188	94
0.65	174	87
0.70	162	81
0.75	151	75