



<b>Product Code:</b>	<b>Issue Number:</b>	<b>Issue Date:</b>	<b>Issued By:</b>
TGTN84	2.0	25/11/2022	ADH

# Tamlex Data Sheet

## Description:

200X100 IP4X GUSSET TEE INSIDE LID

## Features:

Our IP4X turnbuckle trunking offers a range of gusset bends and tees which allow a greater bend radius for cables.

Designed with built-in couplers on all outlets and an integrated lip which fit inside the trunking body, while the lid is designed to fit over the main trunking lid.

Manufactured from continuously hot dipped zinc coated low carbon steel strip to BSEN10346: 2009.

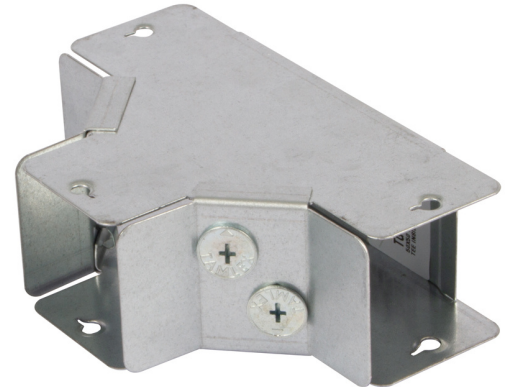

## Technical:

<b>Height</b>	100 mm
<b>Width</b>	200 mm
<b>Length</b>	150 mm
<b>Material</b>	1.0 mm steel
<b>Finish</b>	Pre-Galvanised Steel
<b>Trunking Type</b>	Turnbuckle Gusset Bend
<b>Standard</b>	BS EN 50085-1; BS EN 10346
<b>IP Rating</b>	IP4X

## Important:

Cable trunking is designed such that the main body carries the weight of cables. Trunking should NOT be installed in any way that causes the lid to carry the cable weight.

## Multi-Compartment Options

Standard trunking and accessories are available in multi compartment options. Trunking and accessories are supplied with equal compartments as standard. For unequal compartments, details must be supplied at the time of order. 3 compartment is available in width code 3 and above.

## Weights:

1 Compartment	2 Compartment	3 Compartment
0.960 Kg	1.114 Kg	1.268 Kg

The approximate weights given are for pre-galvanised finish only, in kilograms (nominal) and subject to material thickness tolerance.

## Dimensions: mm

<b>H</b>	198 mm
<b>W</b>	102 mm
<b>D</b>	125 mm
<b>L</b>	98 mm
<b>P1</b>	50 mm

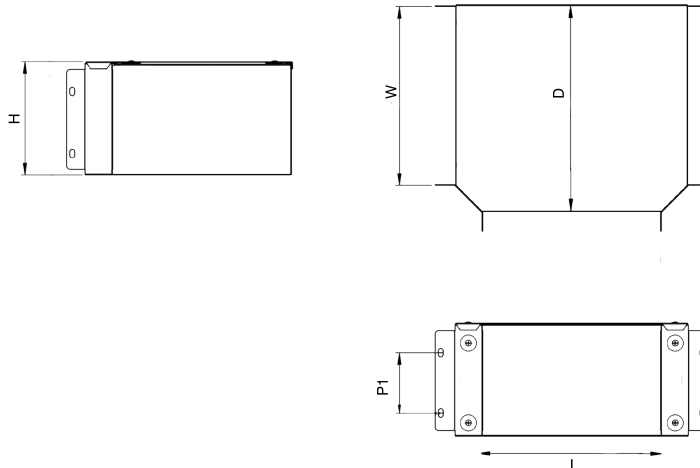

Dimensions are identical for single and multi-compartment