



Product Code:	Issue Number:	Issue Date:	Issued By:
TGTN93	2.0	25/11/2022	ADH

Description:

225X75 IP4X GUSSET TEE INSIDE LID

Features:

Our IP4X turnbuckle trunking offers a range of gusset bends and tees which allow a greater bend radius for cables.

Designed with built-in couplers on all outlets and an integrated lip which fit inside the trunking body, while the lid is designed to fit over the main trunking lid.

Manufactured from continuously hot dipped zinc coated low carbon steel strip to BSEN10346: 2009.

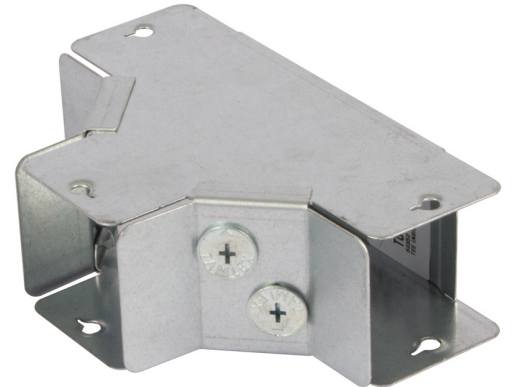

Technical:

Height	75 mm
Width	225 mm
Length	125 mm
Material	1.0 mm steel
Finish	Pre-Galvanised Steel
Trunking Type	Turnbuckle Gusset Bend
Standard	BS EN 50085-1; BS EN 10346
IP Rating	IP4X

Important:

Cable trunking is designed such that the main body carries the weight of cables. Trunking should NOT be installed in any way that causes the lid to carry the cable weight.

Multi-Compartment Options

Standard trunking and accessories are available in multi compartment options. Trunking and accessories are supplied with equal compartments as standard. For unequal compartments, details must be supplied at the time of order. 3 compartment is available in width code 3 and above.

Weights:

1 Compartment	2 Compartment	3 Compartment
0.846 Kg	0.949 Kg	1.052 Kg

The approximate weights given are for pre-galvanised finish only, in kilograms (nominal) and subject to material thickness tolerance.

Dimensions: mm

H	223 mm
W	77 mm
D	100 mm
L	73 mm
P1	35 mm

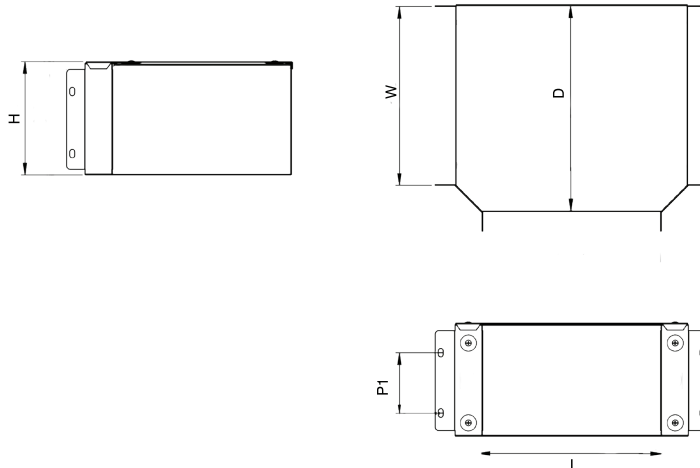

Dimensions are identical for single and multi-compartment