



PRODUCT CATALOGUE



STEEL CABLE MANAGEMENT

STEEL CABLE MANAGEMENT

As a British manufacturer of cable management products, Tamlex is uniquely placed. With over 50 years experience and expertise, its proven capability to supply from floor service boxes to power and lighting trunking systems.

As a design orientated manufacturer, Tamlex has established many standard product ranges as well as special products to suit individual installation circumstances that incorporate features and benefits for the installer.

At Tamlex we strive for excellence in providing cable management products to our expanding customer base. We place a high value on minimising the impact to the environment and are committed to the maintenance and improvement of environmental practice in our day to day operations as a manufacturer and distributor.

Section Content

IP4X Trunking	02	Modular Flush Screed Trunking	40
Lighting Trunking	10	Flush Screed Trunking	43
Dado, Skirting & Bench Trunking	12	Switch, Socket & Adaptable Boxes	45
Pedestal boxes	21	Steel Conduit	47
Cable Tray	22	Strut Framework & Accessories	48
FastConnect Basket Tray	28	General Fixings	56
Service Boxes & Plates	34	Technical Information	57



KEY FEATURES:



IP4X COMPLIANT DISTRIBUTION TRUNKING

Available Lid Fixings

Standard:



Turnbuckle Screw

Optional:



M6 Tamperproof Screw



M6 Universal Screw
(pozi, slot and hex)

Material

Steel manufactured to BSEN 10346: 2015

Finish

Pre-galvanised continuously hot dipped zinc coated low carbon steel strip.

Supplied

As standard in 3 metre lengths and complete with our simple turnbuckle fixing system.

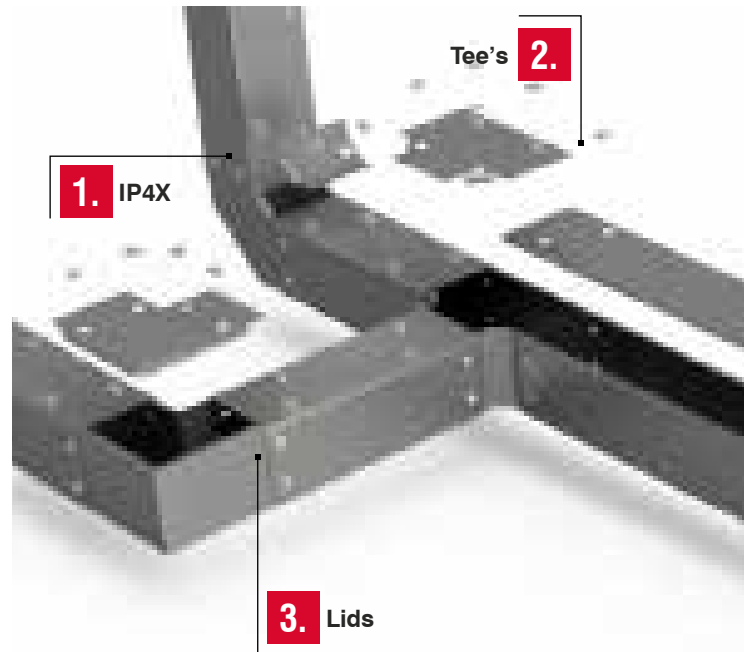

1. IP4X

All Tamlex trunking systems are IP4x compliant as standard

2. Tee's

All 2 & 3 compartment tees include a bridge flyover, this reduces the cable capacity by 50%

3. Lids

Accessory Lid overlap trunking lid and incorporate a pre-assembled turnbuckle fastener

4. Reducers

When ordering reducers, specify the largest trunking size first, e.g. TRE44-22

IP4X TRUNKING FEATURES

FEATURES:

Our IP4X distribution trunking features an innovative integrated coupler and overlapping lid on accessories.

The small step in the accessory base seamlessly slides over the base of the trunking lengths, while the extended lid slots over the trunking length lid to provide an IP4X seal.

The threaded screw holes on either side of the accessory work as locators to ensure the system connects into the correct compliant position. This provides a much easier and quicker installation and an overall more aesthetically pleasing product.

Our snap-fit cover strap is available to keep the IP4X integrity on the trunking lengths by utilising our full height one-piece 'U' shaped internal coupler.

Special fittings such as unequal tees, offsets, risers, bell mouths and bespoke angled bends can be made to order.

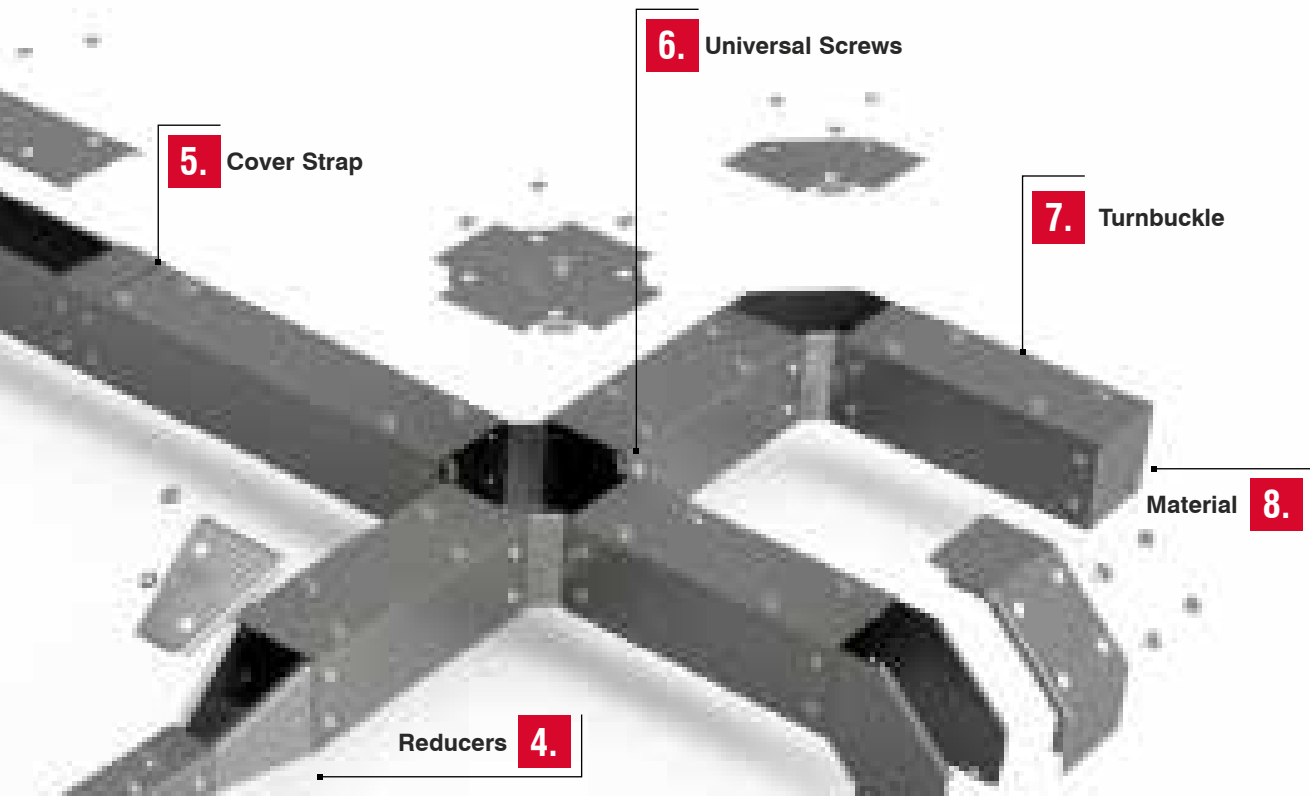

5. Cover Straps
IP4x cover straps are only required for length-to-length joins (supplied separately)

6. Universal Screws
Bends and tees are supplied with M6 Universal multi-head safety end screws

7. Turnbuckle
Turnbuckle fixing with its cross head allows easy installation and removal of lids

8. Material
Material and finishes available are mild steel pre-galvanized or powder coated to order

DISTRIBUTION TRUNKING

Measurements:
Millimetres (mm)
unless stated
otherwise

TRUNKING SIZE GUIDE

TRUNKING SIZE		SIZE CODE (##)	NO. OF COMP. AVAILABLE		
WIDTH	HEIGHT		1 COMP	2 COMP	3 COMP
50	50	22	✓	✓	-
75	50	32	✓	✓	✓
75	75	33	✓	✓	✓
100	50	42	✓	✓	✓
100	75	43	✓	✓	✓
100	100	44	✓	✓	✓
150	50	62	✓	✓	✓
150	75	63	✓	✓	✓
150	100	64	✓	✓	✓
150	150	66	✓	✓	✓
200	50	82	✓	✓	✓
200	75	83	✓	✓	✓
200	100	84	✓	✓	✓
200	150	86	✓	✓	✓
200	200	88	✓	✓	✓
225	50	92	✓	✓	✓
225	75	93	✓	✓	✓
225	100	94	✓	✓	✓
225	150	96	✓	✓	✓
225	225	99	✓	✓	✓
300	50	122	✓	✓	✓
300	75	123	✓	✓	✓
300	100	124	✓	✓	✓
300	150	126	✓	✓	✓
300	200	128	✓	✓	✓
300	225	129	✓	✓	✓
300	300	1212	✓	-	-

Other sizes available on request

COMPARTMENT OPTIONS

Standard trunking is available in multi-compartment options. Trunking and accessories are supplied with equal compartments as standard. For unequal compartments, details must be supplied at the time of order.

LENGTHS COMPARTMENT OPTIONS

For 1 compartment trunking there is no need to change the catalogue number. **Example TRE33**
For 2 compartment trunking add '/2' to the end of the catalogue number. **Example TRE33/2**
For 3 compartment trunking add '/3' to the end of the catalogue number. **Example TRE33/3**

ACCESSORIES COMPARTMENT OPTIONS

For 1 compartment accessories there is no need to change the catalogue number. **Example TGBT33**
For 2 compartment accessories add '/2' to the end of the catalogue number. **Example TGBT33/2**
For 3 compartment accessories add '/3' to the end of the catalogue number. **Example TGBT33/3**

PRODUCT CODE GUIDE

For example to order TRE33 with two compartments follow this example

Trunking Cat. No.	Width (Inches)	Height (Inches)	Compartments
TRE	3	3	/ 2



MULTI-COMPARTMENT TRUNKING OPTIONS

- For 2 compartment fittings add suffix '/2' e.g. TRE33/2.
- For 3 compartment fittings add suffix '/3' e.g. TRE33/3.

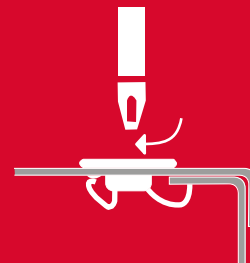

FASTER - QUARTER TURN FIXING

Speed up your installation with our quarter turn positive lock fixings

TRUNKING

- Made from pre-galvanised steel
- Manufactured from continuously hot dipped zinc coated low carbon steel strip to BS EN 10346: 2015.
- All dimensions relate to the inside measurement.
- All lid fixings and couplers are included.
- Trunking can be powder coated to any RAL colour.
- Trunking is available with a selection of lid fixings.
- Other sizes are available on request.



TRE33

SINGLE COMPARTMENT TURNBUCKLE

Supplied complete with turnbuckle lid.

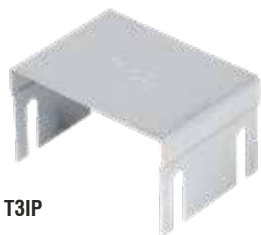

T3IP

IP4X COVER STRAP

To facilitate length to length compliance



TRE62/3

See page opposite for full list of multi-compartment trunking sizes

Available Lid Fixings

Standard:



Turnbuckle Screw

Optional:



M6 Tamperproof Screw



M6 Universal Screw (pozi, slot and hex)



TURNBUCKLE

CAT. NO.	W	H	L m
TRE22	50	50	3
TRE32	75	50	3
TRE33	75	75	3
TRE42	100	50	3
TRE43	100	75	3
TRE44	100	100	3
TRE62	150	50	3
TRE63	150	75	3
TRE64	150	100	3
TRE66	150	150	3
TRE82	200	50	3
TRE83	200	75	3
TRE84	200	100	3
TRE86	200	150	3
TRE88	200	200	3
TRE92	225	50	3
TRE93	225	75	3
TRE94	225	100	3
TRE96	225	150	3
TRE99	225	225	3
TRE122	300	50	3
TRE123	300	75	3
TRE124	300	100	3
TRE126	300	150	3
TRE128	300	200	3
TRE129	300	225	3
TRE1212	300	300	3

Measurements:
Millimetres (mm)
unless stated
otherwise

All Trunking
accessories
compatible with
TRE systems

CAT. NO.	W
T2IP	50
T3IP	75
T4IP	100
T6IP	150
T8IP	200
T9IP	225
T12IP	300

MULTI-COMPARTMENT TRUNKING

2 COMPARTMENT CAT. NO.	3 COMPARTMENT CAT. NO.	W	H	L m
TRE22/2	N/A	50	50	3
TRE32/2	TRE32/3	75	50	3
TRE33/2	TRE33/3	75	75	3
TRE42/2	TRE42/3	100	50	3
TRE43/2	TRE43/3	100	75	3
TRE44/2	TRE44/3	100	100	3
TRE62/2	TRE62/3	150	50	3
TRE63/2	TRE63/3	150	75	3
TRE64/2	TRE64/3	150	100	3
TRE66/2	TRE66/3	150	150	3

Other sizes available on request. See table opposite.

TRUNKING ACCESSORIES

Measurements:

Millimetres (mm)
unless stated
otherwise

All Trunking
accessories compatible
with TRE systems

Other sizes available
on request



**90° GUSSET BEND
TOP LID** TGBT33

SIZE CODE	90° CAT. NO.	W	H
22	TGBT22	50	50
32	TGBT33	75	75
42	TGBT42	100	50
43	TGBT44	100	100
44	TGBT66	150	150



**90° GUSSET BEND
INSIDE LID** TGBN33

90° CAT. NO.	W	H
TGBN22	50	50
TGBN33	75	75
TGBN42	100	50
TGBN44	100	100
TGBN66	150	150



**90° GUSSET BEND
OUTSIDE LID** TGBO33

90° CAT. NO.	W	H
TGBO22	50	50
TGBO33	75	75
TGBO42	100	50
TGBO44	100	100
TGBO66	150	150



**45° GUSSET BEND
TOP LID** TGHT33

45° CAT. NO.	W	H
TGHT22	50	50
TGHT33	75	75
TGHT42	100	50
TGHT44	100	100
TGHT66	150	150



**45° GUSSET BEND
INSIDE LID** TGHN33

45° CAT. NO.	W	H
TGHN22	50	50
TGHN33	75	75
TGHN42	100	50
TGHN44	100	100
TGHN66	150	150



**45° GUSSET BEND
OUTSIDE LID** TGH033

45° CAT. NO.	W	H
TGHO22	50	50
TGHO33	75	75
TGHO42	100	50
TGHO44	100	100
TGHO66	150	150



**GUSSET TEE
TOP LID** TGTT33

CAT. NO.	W	H
TGTT22	50	50
TGTT33	75	75
TGTT42	100	50
TGTT44	100	100
TGTT66	150	150



**GUSSET TEE
INSIDE LID** TGTN33

CAT. NO.	W	H
TGTN22	50	50
TGTN33	75	75
TGTN42	100	50
TGTN44	100	100
TGTN66	150	150



**GUSSET TEE
OUTSIDE LID** TGT033

45° CAT. NO.	W	H
TGTO22	50	50
TGTO33	75	75
TGTO42	100	50
TGTO44	100	100
TGTO66	150	150

**Multi-compartment
options:**

2 Comp: add suffix /2
3 Comp: add suffix /3



GUSSET FOURWAY

TGFT33

CAT. NO.	W	H
TGFT22	50	50
TGFT33	75	75
TGFT42	100	50
TGFT44	100	100
TGFT66	150	150

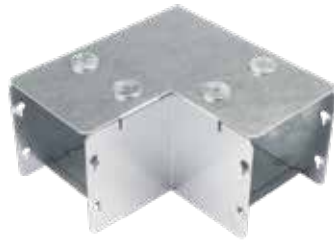

SHARP BEND TOP LID

TNET33

CAT. NO.	W	H
TNET22	50	50
TNET33	75	75
TNET42	100	50
TNET44	100	100
TNET66	150	150



SHARP BEND INSIDE LID

TNEN33

CAT. NO.	W	H
TNEN22	50	50
TNEN33	75	75
TNEN42	100	50
TNEN44	100	100
TNEN66	150	150

Measurements:
Millimetres (mm)
unless stated
otherwise

All Trunking
accessories compatible
with TRE systems

Other sizes available
on request

SIZE CODE

22

32

33

42

43

44

62

63

64

66

82

83

84

86

88

92

93

94

96

99

122

123

124

126

128

129

1212

**Multi-compartment
options:**
2 Comp: add suffix /2
3 Comp: add suffix /3



SHARP BEND OUTSIDE LID

TNEO33

CAT. NO.	W	H
TNEO22	50	50
TNEO33	75	75
TNEO42	100	50
TNEO44	100	100
TNEO66	150	150



SHARP TEE

TNNT33

CAT. NO.	W	H
TNNT22	50	50
TNNT33	75	75
TNNT42	100	50
TNNT44	100	100
TNNT66	150	150



STOP END

GSE33

CAT. NO.	W	H
GSE22	50	50
GSE33	75	75
GSE42	100	50
GSE44	100	100
GSE66	150	150



EARTH BONDING STRAP

DESCRIPTION **CAT. NO.**

Earth bonding strap for
trunking

EBS

Pack quantity: 50 per pack.

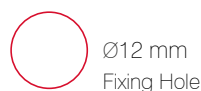

Ø12 mm
Fixing Hole

TURNBUCKLE

DESCRIPTION **CAT. NO.**

Tamlex turnbuckle screw **TTB**

Pack Quantity: 25 per pack.



TF080

OPTIONAL FIXINGS

DESCRIPTION **CAT. NO.**

M6 Universal hex head
screw **TF080**

M6 Pin head tamperproof
screw **TF066**

Pack Quantity: 100 per pack.

TRUNKING ACCESSORIES

Measurements:

Millimetres (mm)
unless stated
otherwise

All Trunking
accessories compatible
with TRE systems

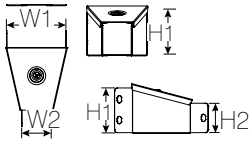

TRC33-22

REDUCER

SIZE CODE (##)	CAT. NO.	W1	H1	W2	H2
22	TRC33-22	75	75	50	50
32	TRC42-22	100	50	50	50
33	TRC44-22	100	100	50	50
42	TRC44-33	100	100	75	75
43	TRC64-44	150	100	100	100
44	TRC66-33	150	150	75	75
62	TRC66-44	150	150	100	100

Other sizes available on request.



REL3TB

TURNBUCKLE SPARE LIDS

CAT. NO.	W	L (m)
REL2TB	50	3
REL3TB	75	3
REL4TB	100	3
REL6TB	150	3
REL8TB	200	3
REL9TB	225	3
REL12TB	300	3

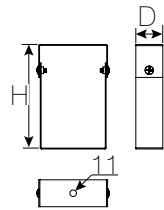

GHA33

SUSPENSION

CAT. NO.	TRUNKING SIZE		SUSPENSION SIZE	
	W	H	H	D
GHA22	50	50	122	45
GHA33	75	75	147	45
GHA44	100	100	172	45
GHA66	150	150	222	45

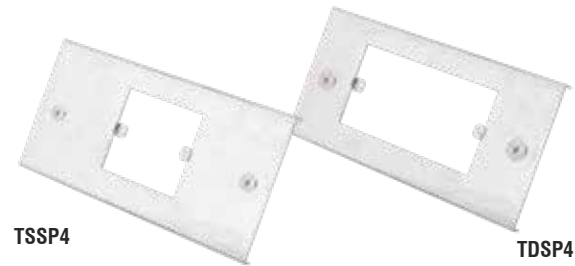

TSSP4

TDSP4

SOCKET ADAPTOR PLATES

DESCRIPTION	CAT. NO.	W	H	D
100mm Single socket plate	TSSP4	282	104	12
150mm Single socket plate	TSSP6	282	155	12
100mm Double socket plate	TDSP4	282	104	12
150mm Double socket plate	TDSP6	282	155	12

Simply replace
'##' with the
relevant trunking
size code above:
TGFT33/2



CR3

CABLE RETAINER

CAT. NO.	TRUNKING WIDTH
CR2	50
CR3	75
CR4	100
CR6	150

Supplied in 1's.



GSCU33

U SLEEVE COUPLER

CAT. NO.	TRUNKING WIDTH
GSCU22	50
GSCU33	75
GSCU44	100
GSCU66	150

Supplied in 1's.



GSC33

SLEEVE COUPLER

CAT. NO.	TRUNKING WIDTH
GSC22	50
GSC33	75
GSC44	100
GSC66	150

Supplied in pairs.
For multi-compartment trunking

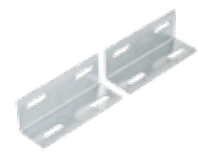

GCA33

FLANGE COUPLER

CAT. NO.	TRUNKING HEIGHT
GCA22	50
GCA33	75
GCA44	100
GCA66	150

Supplied in pairs.

“

A BESPOKE SOLUTION CAN OFFER

YOU DURABILITY AND FLEXIBILITY”

STEEL CABLE TRUNKING SYSTEMS

Tamlex can offer steel cable trunking systems with a number of security options depending on the application.

**CALL POINTS**

Our tamperproof tailored power and call point modules have been designed with a durable double skin that prevents access to internal parts. In addition, these modules often must fit into a small footprint and be fast to install to minimise disruption to staff and inmates.

SPECIAL SECURE BOXES

Adaptable steel boxes with a galvanised (BS EN 10346) or powder coated finish can be manufactured with tamperproof lid fixings. These can be manufactured to any size to meet the individual requirements.



LIGHTING TRUNKING

Measurements:
Millimetres (mm)
unless stated
otherwise



LIGHTING TRUNKING BODY

50mm x 50mm Galvanised Lighting Trunking Body

- 3m & 4.5m lengths as standard.
- Snap-on lid fits both sizes.
- Couplers simply slide into position.
- Standard 2" trunking accessories can also be used.
- Manufactured from continuously hot dipped zinc coated low carbon steel strip to BS EN 10346: 2015.
- Lighting trunking can be powder coated to any RAL colour.



LTB 3

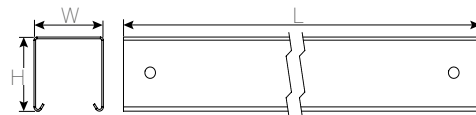

CAT. NO.	W	H	Lm
LTB 3	50	50	3
LTB45	50	50	4.5

Couplers & lid must be ordered separately.

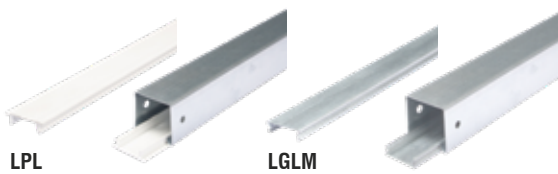

LPL

LGLM

TRUNKING LIDS

A 'Snap-on' lid trunking system for fast, tool free installations

CAT. NO.	W	H	Lm
LPL white (plastic)	50	50	2
LGLM metal (galvanised)	50	50	2



LLC3

COUPLERS

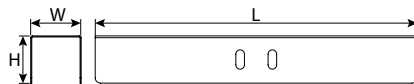

CAT. NO.	W	H	L m
LLC 3	50	50	240
LSC 3	50	50	150

Long couplers should be used when the trunking is suspended.

Couplers are designed to bite fit against the return flange on the trunking body.

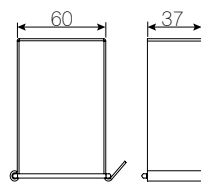

LTS 3-11

TRUNKING SUSPENSION HANGER

CAT. NO.	HOLE DIA.	TO ACCEPT
LTS 3-11	11	M10 Rod
LTS 3-20	20	20 mm Conduit

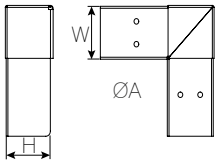

TOP LID BENDS

CAT. NO.	W	H	A
L2TC 3	50	50	90°
L2TC 3 45	50	50	45°

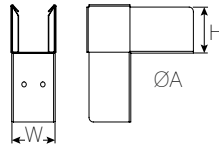

OUTSIDE LID BENDS

CAT. NO.	W	H	A
L2OC 3	50	50	90°
L2OC 3 45	50	50	45°

Measurements:
Millimetres (mm)
unless stated
otherwise

Couplers are
designed to bite fit
against the return
flange on the
trunking body.

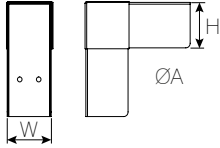

INSIDE LID BENDS

CAT. NO.	W	H	A
L2IC 3	50	50	90°
L2IC 3 45	50	50	45°

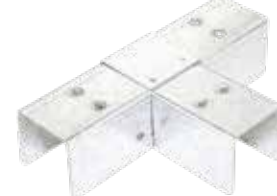
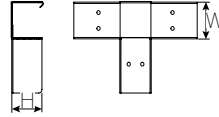

TOP LID TEE

CAT. NO.	W	H
L3TC 3	50	50

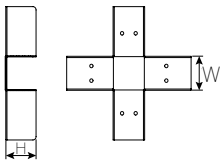

TOP LID FOURWAY

CAT. NO.	W	H
L4TC 3	50	50

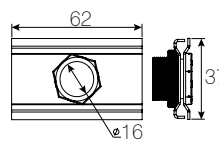

LIGHT FITTING SUSPENSION

CAT. NO.
LFS

Supplied with long brass bush and lock ring.



STOP END

CAT. NO.	W	H
LBE 3	50	50

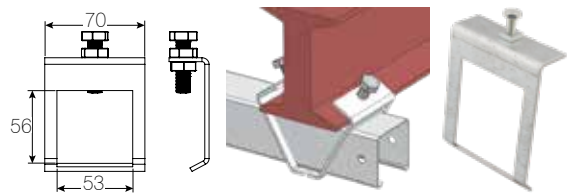

GIRDER BEAM CLAMP

Supplied separately.

CAT. NO.
LGC 3



CABLE RETAINER

CAT. NO.
LCR

Trunking supplied separately.

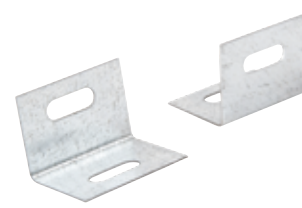

FLANGE END

CAT. NO.
LFE 3

Supplied in pairs.

KEY FEATURES:



3x profiles
1, 2 & 3 compartments

Material
Steel material to BS EN 10346: 2015

Finish
Galvanised sheet steel available self-coloured or to any RAL colours on request

Standard colours
White: Add suffix /W
Black: Add suffix /B
Galvanised: Add suffix /G

Supplied
As standard in 2 metre lengths

1. Cover Straps

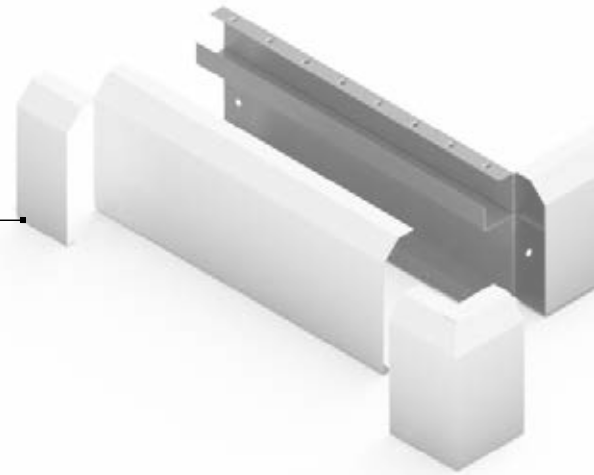

2. Bend & Tees

1. Cover Straps

Cover straps are only required for length-to-length joins

2. Bend & Tees

All bends and tee lids overlap the trunking to prevent the need for additional joint couplers

3. Internal bend

A generous internal 50mm bend radius for Cat6a compliance

4. Trunking profile

Chamfered skirting or Square dado profiles available

STEEL DADO, SKIRTING & BENCH TRUNKING

FEATURES:

Design with durability and ease of installation in mind. An ideal solution with superior mechanical strength for high traffic environments such as hospitals, offices, schools, colleges, laboratories, hotels and public buildings whilst offering excellent screening capability and first-class fire protection.

All bends and tee covers overlap the trunking to prevent the need for additional joint couplers plus increasing ingress protection for an aesthetically pleasing and cleaner design.

The cover can be powder coated to an RAL colour which not only offers an attractive finish but is also highly resilient to damage during use and installation.

Optional security tamper proof fixings are available to use in a variety of projects to safeguard against vandalism and prevent access.

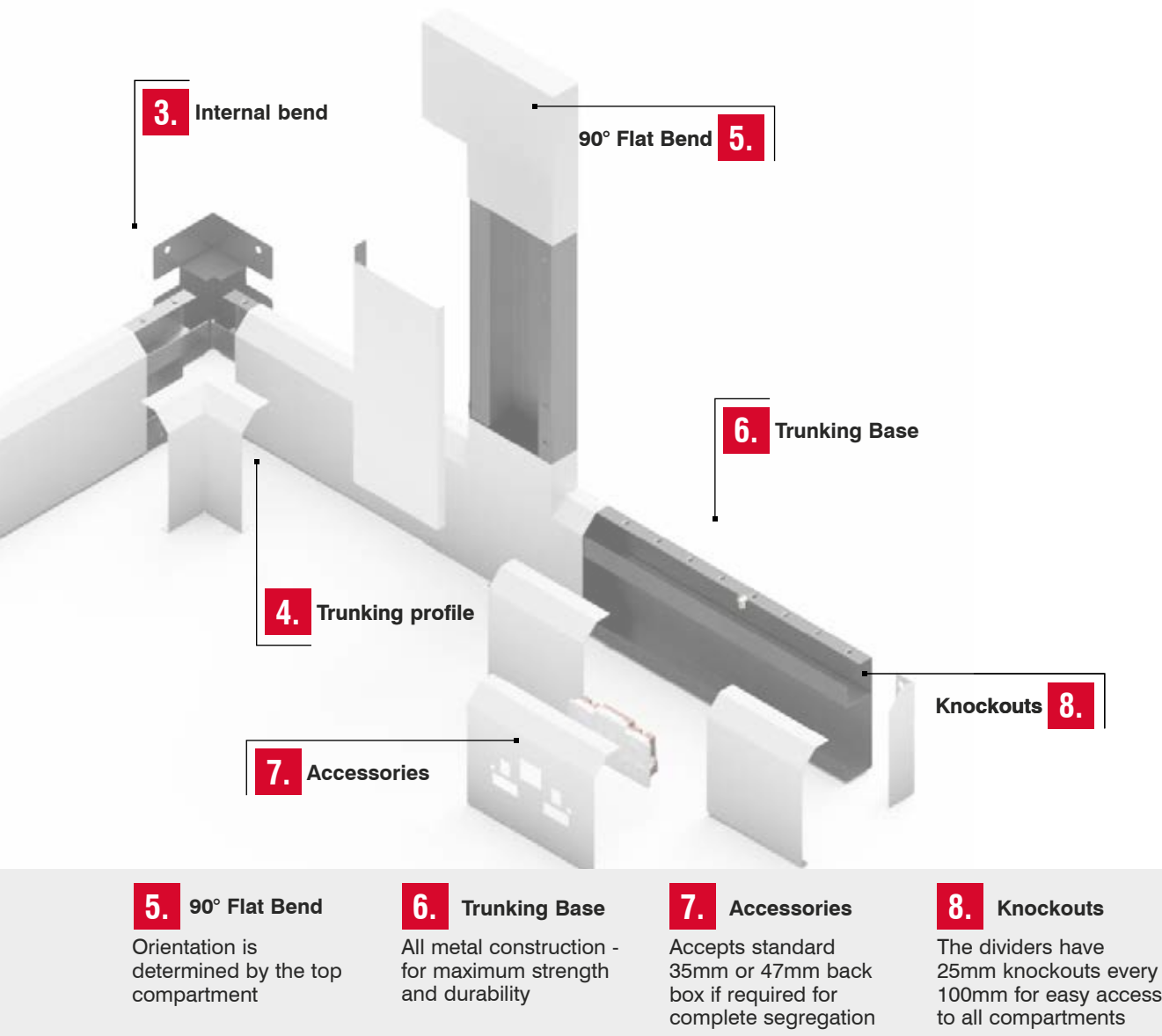

STEEL DADO TRUNKING

Measurements:

Millimetres (mm)
unless stated
otherwise

Lid Colour Suffix:

White: Add /W
Black: Add /B
Galvanised: Add /G

Cat6a Compliant:

Accessories are
Cat6a compliant

Orientation is
determined by the
top compartment

SQUARE DADO TRUNKING

This range combines excellent screening capability and clean design with superior mechanical strength. Ideal for hospitals, laboratories or universities whilst also offering first class fire protection.

- Perimeter trunking system offers the end user a quick and easy to fit system
- All metal construction - for maximum strength and durability
- All partitions have 25mm knockouts between compartments for ease of installation
- Powder coating is low smoke zero halogen
- Available in any RAL colour
- Full range of Cat6a compliant accessories available



TDA62

50	50	50
100	150	100
		50

DESCRIPTION	CAT. NO.	H	D	L m
2 Compartment	TDA62/#	150	60	2
2 Compartment	TDA82/#	200	60	2
3 Compartment	TDA83/#	200	60	2



TDA62FBD

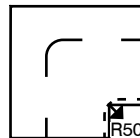

90° FLAT BENDS - DOWNWARDS

DESCRIPTION	CAT. NO.	H	D
2 Compartment	TDA62FBD/#	150	60
2 Compartment	TDA82FBD/#	200	60
3 Compartment	TDA83FBD/#	200	60



TDA62FBU

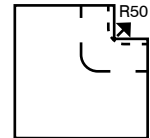

90° FLAT BENDS - UPWARDS

DESCRIPTION	CAT. NO.	H	D
2 Compartment	TDA62FBU/#	150	60
2 Compartment	TDA82FBU/#	200	60
3 Compartment	TDA83FBU/#	200	60

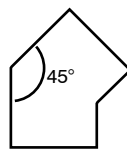

TDA62IB

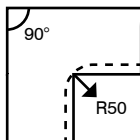

45° & 90° INTERNAL BENDS

DESCRIPTION	CAT. NO.	H	D
2 Compartment	TDA62IB/#	150	60
2 Compartment	TDA82IB/#	200	60
3 Compartment	TDA83IB/#	200	60
2 Compartment	TDA62IB45/#	150	60
2 Compartment	TDA82IB45/#	200	60
3 Compartment	TDA83IB45/#	200	60

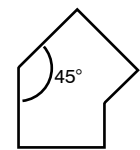

TDA62EB

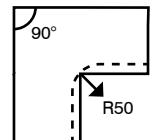

45° & 90° EXTERNAL BENDS

DESCRIPTION	CAT. NO.	H	D
2 Compartment	TDA62EB/#	150	60
2 Compartment	TDA82EB/#	200	60
3 Compartment	TDA83EB/#	200	60
2 Compartment	TDA62EB45/#	150	60
2 Compartment	TDA82EB45/#	200	60
3 Compartment	TDA83EB45/#	200	60

STEEL DADO TRUNKING



TDA62TDL

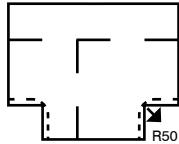

FLAT TEE DOWNWARDS LEFT

DESCRIPTION	CAT. NO.	H	D
2 Compartment	TDA62TDL/#	150	60
2 Compartment	TDA82TDL/#	200	60
3 Compartment	TDA83TDL/#	200	60



TDA62TDR

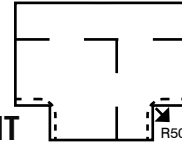

FLAT TEE DOWNWARDS RIGHT

DESCRIPTION	CAT. NO.	H	D
2 Compartment	TDA62TDR/#	150	60
2 Compartment	TDA82TDR/#	200	60
3 Compartment	TDA83TDR/#	200	60

Measurements:
Millimetres (mm)
unless stated
otherwise

Lid Colour Suffix:
White: Add /W
Black: Add /B
Galvanised: Add /G

Cat6a Compliant:
Accessories are
Cat6a compliant

Orientation is
determined by the
top compartment



TDA62TUL

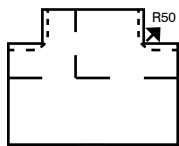

FLAT TEE UPWARDS LEFT

DESCRIPTION	CAT. NO.	H	D
2 Compartment	TDA62TUL/#	150	60
2 Compartment	TDA82TUL/#	200	60
3 Compartment	TDA83TUL/#	200	60



TDA62TUR

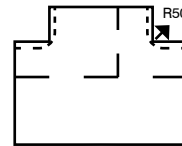

FLAT TEE UPWARDS RIGHT

DESCRIPTION	CAT. NO.	H	D
2 Compartment	TDA62TUR/#	150	60
2 Compartment	TDA82TUR/#	200	60
3 Compartment	TDA83TUR/#	200	60



TDA6SSP

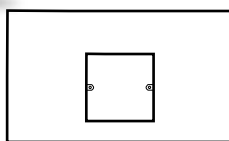

SINGLE SOCKET PLATES

DESCRIPTION	CAT. NO.	H	D
150 mm Dado	TDA6SSP/#	150	60
200 mm Dado	TDA8SSP/#	200	60



TDA62DSP

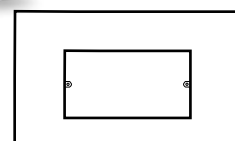

DOUBLE SOCKET PLATES

DESCRIPTION	CAT. NO.	H	D
150 mm Dado	TDA6DSP/#	150	60
200 mm Dado	TDA8DSP/#	200	60

STEEL DADO TRUNKING

Measurements:
Millimetres (mm)
unless stated
otherwise

Lid Colour Suffix:
White: Add /W
Black: Add /B
Galvanised: Add /G

Cat6a Compliant:
Accessories are
Cat6a compliant

Orientation is
determined by the
top compartment



TDA6TSS

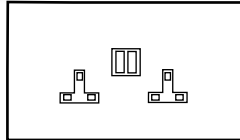

2 GANG SWITCHED SOCKET PLATES

DESCRIPTION	CAT. NO.	H	D
150mm Dado	TDA6TSS/#	150	60
200mm Dado	TDA8TSS/#	200	60



TDA6E4M

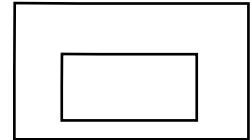

2 GANG EURO 4 MODULE PLATES

DESCRIPTION	CAT. NO.	H	D
150mm Dado	TDA6E4M/#	150	60
200mm Dado	TDA8E4M/#	200	60



TDA6EC

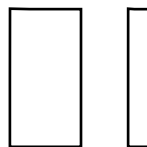

END CAPS

DESCRIPTION	CAT. NO.	H	D
150mm End cap	TDA6EC/#	150	60
200mm End cap	TDA8EC/#	200	60

Supplied in pairs.



TDA6C

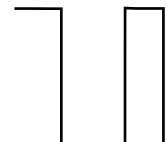

JOINT COVERS

DESCRIPTION	CAT. NO.	H	D
150mm Cover	TDA6C/#	150	60
200mm Cover	TDA8C/#	200	60

**BESPOKE
BENDS & TEES**
AVAILABLE ON REQUEST



CHAMFERED SKIRTING TRUNKING

This range combines excellent screening capability and clean design with superior mechanical strength. Ideal for hospitals, laboratories or universities whilst also offering first class fire protection.

- Perimeter trunking system offers the end user a quick and easy to fit system
- All metal construction - for maximum strength and durability
- All partitions have 25mm knockouts between compartments for ease of installation
- Powder coating is low smoke zero halogen
- Available in any RAL colour
- Full range of Cat6a compliant accessories available

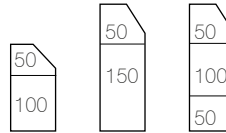

TSK62

DESCRIPTION	CAT. NO.	H	D	L m
2 Compartment	TSK62/#	150	60	2
2 Compartment	TSK82/#	200	60	2
3 Compartment	TSK83/#	200	60	2

Measurements:
Millimetres (mm)
unless stated
otherwise

Lid Colour Suffix:
White: Add /W
Black: Add /B
Galvanised: Add /G

Cat6a Compliant:
Accessories are
Cat6a compliant

Orientation is
determined by the
top compartment



TSK62FBD

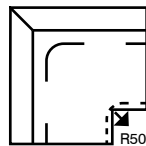

90° FLAT BENDS - DOWNWARDS

DESCRIPTION	CAT. NO.	H	D
2 Compartment	TSK62FBD/#	150	60
2 Compartment	TSK82FBD/#	200	60
3 Compartment	TSK83FBD/#	200	60



TSK62FBU

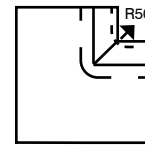

90° FLAT BENDS - UPWARDS

DESCRIPTION	CAT. NO.	H	D
2 Compartment	TSK62FBU/#	150	60
2 Compartment	TSK82FBU/#	200	60
3 Compartment	TSK83FBU/#	200	60

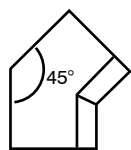

TSK62IB

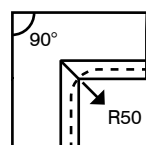

45° & 90° INTERNAL BENDS

DESCRIPTION	CAT. NO.	H	D
2 Compartment	TSK62IB/#	150	60
2 Compartment	TSK82IB/#	200	60
3 Compartment	TSK83IB/#	200	60
2 Compartment	TSK62IB45/#	150	60
2 Compartment	TSK82IB45/#	200	60
3 Compartment	TSK83IB45/#	200	60

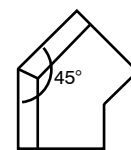

TSK62EB

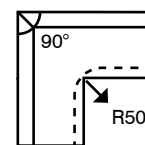

45° & 90° EXTERNAL BENDS

DESCRIPTION	CAT. NO.	H	D
2 Compartment	TSK62EB/#	150	60
2 Compartment	TSK82EB/#	200	60
3 Compartment	TSK83EB/#	200	60
2 Compartment	TSK62EB45/#	150	60
2 Compartment	TSK82EB45/#	200	60
3 Compartment	TSK83EB45/#	200	60

STEEL SKIRTING TRUNKING

Measurements:

Millimetres (mm)
unless stated
otherwise

Lid Colour Suffix:

White: Add /W
Black: Add /B
Galvanised: Add /G

Cat6a Compliant:

Accessories are
Cat6a compliant

Orientation is
determined by the
top compartment

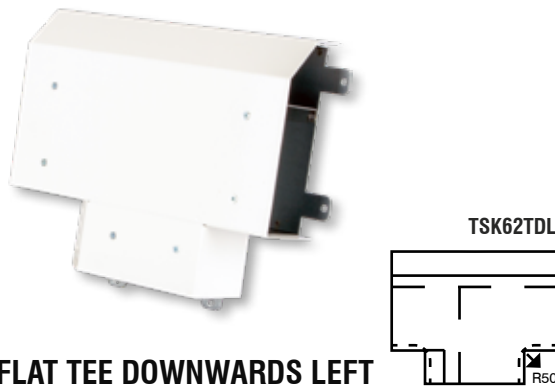

FLAT TEE DOWNWARDS LEFT

DESCRIPTION	CAT. NO.	H	D
2 Compartment	TSK62TDL/#	150	60
2 Compartment	TSK82TDL/#	200	60
3 Compartment	TSK83TDL/#	200	60

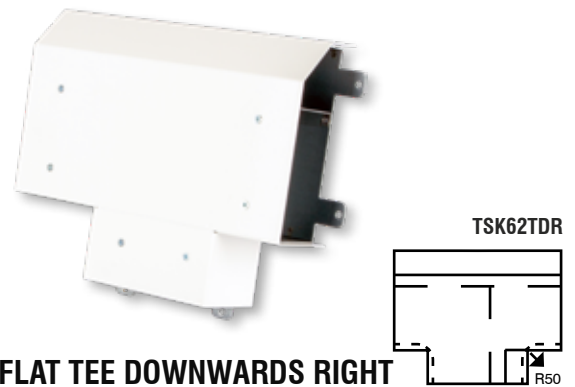

FLAT TEE DOWNWARDS RIGHT

DESCRIPTION	CAT. NO.	H	D
2 Compartment	TSK62TDR/#	150	60
2 Compartment	TSK82TDR/#	200	60
3 Compartment	TSK83TDR/#	200	60

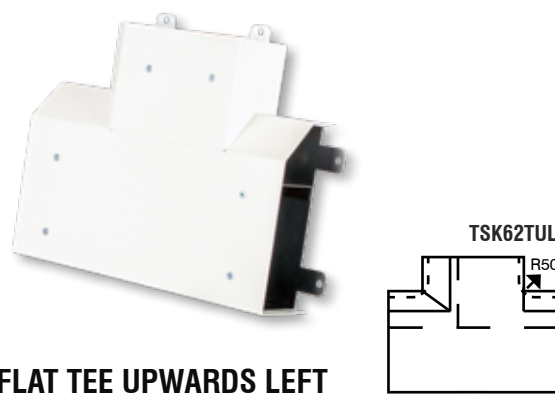

FLAT TEE UPWARDS LEFT

DESCRIPTION	CAT. NO.	H	D
2 Compartment	TSK62TUL/#	150	60
2 Compartment	TSK82TUL/#	200	60
3 Compartment	TSK83TUL/#	200	60

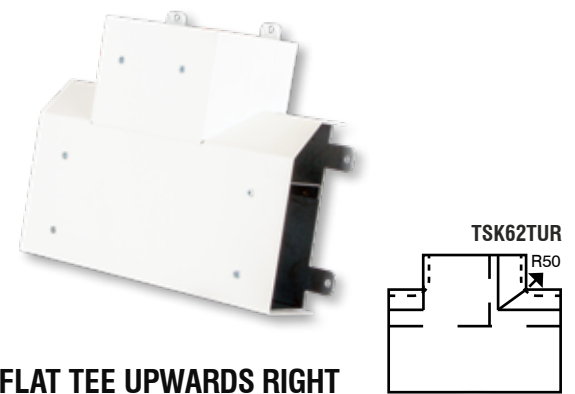

FLAT TEE UPWARDS RIGHT

DESCRIPTION	CAT. NO.	H	D
2 Compartment	TSK62TUR/#	150	60
2 Compartment	TSK82TUR/#	200	60
3 Compartment	TSK83TUR/#	200	60

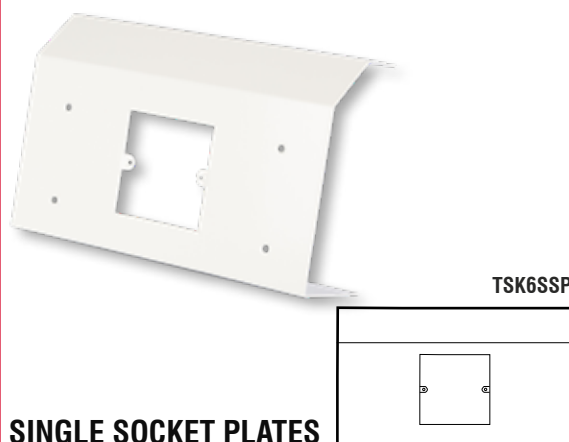

SINGLE SOCKET PLATES

DESCRIPTION	CAT. NO.	H	D
150 mm Skirting	TSK6SSP/#	150	60
200 mm Skirting	TSK8SSP/#	200	60

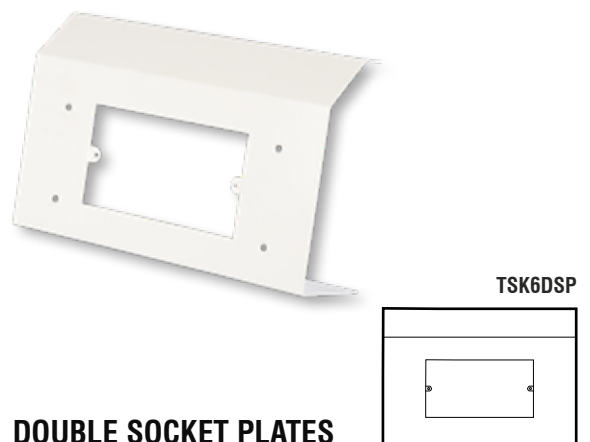

DOUBLE SOCKET PLATES

DESCRIPTION	CAT. NO.	H	D
150mm Skirting	TSK6DSP/#	150	60
200mm Skirting	TSK8DSP/#	200	60

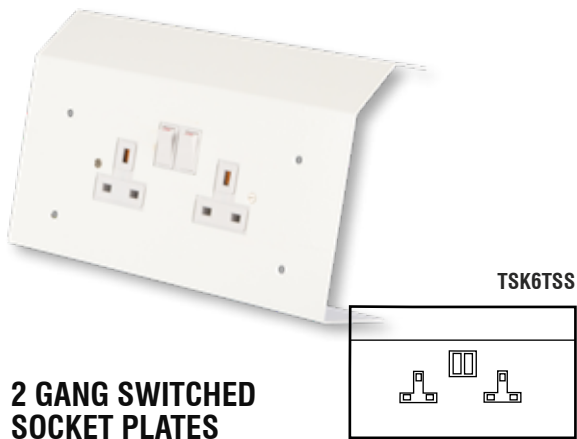

2 GANG SWITCHED SOCKET PLATES

DESCRIPTION	CAT. NO.	H	D
150mm Skirting	TSK6TSS/#	150	60
200mm Skirting	TSK8TSS/#	200	60

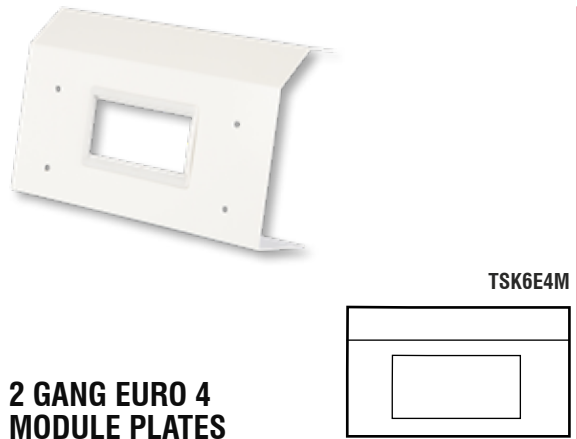

2 GANG EURO 4 MODULE PLATES

DESCRIPTION	CAT. NO.	H	D
150mm Skirting	TSK6E4M/#	150	60
200mm Skirting	TSK8E4M/#	200	60

Measurements:
Millimetres (mm)
unless stated
otherwise

Lid Colour Suffix:
White: Add /W
Black: Add /B
Galvanised: Add /G

Cat6a Compliant:
Accessories are
Cat6a compliant

Orientation is
determined by the
top compartment

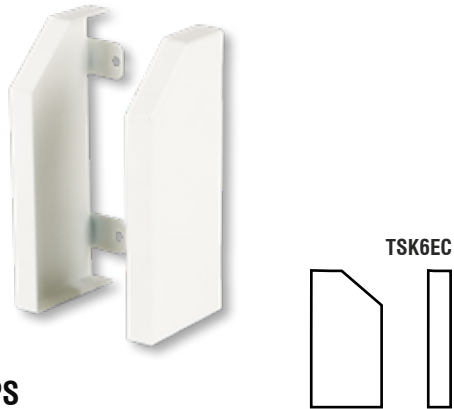

END CAPS

DESCRIPTION	CAT. NO.	H	D
150mm End Cap	TSK6EC/#	150	60
200mm End Cap	TSK8EC/#	200	60

Supplied in pairs.

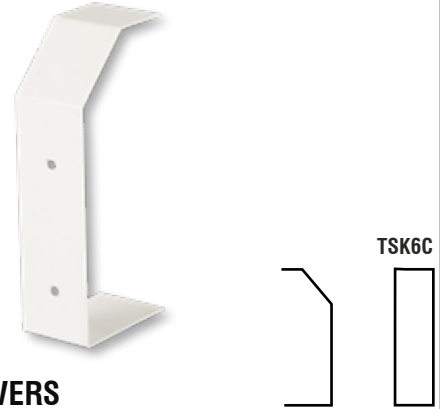

JOINT COVERS

DESCRIPTION	CAT. NO.	H	D
150mm Cover	TSK6C/#	150	60
200mm Cover	TSK8C/#	200	60

BESPOKE BENDS & TEES

AVAILABLE ON REQUEST

STEEL BENCH TRUNKING

Measurements:

Millimetres (mm)
unless stated
otherwise

Lid Colour Suffix:

White: Add /W
Black: Add /B
Galvanised: Add /G

BENCH TRUNKING

Tamlex bench trunking provides a robust angled system that can be mounted directly on to desks, work benches or fitted under shelving. Fully compatible with UK standard power and data accessories.

- Quick and easy to fit system
- Manufactured with galvanised sheet steel body and lid to BS EN 10346: 2015
- All metal construction - for maximum strength and durability
- Supplied complete with joint coupler
- Powder coating is low smoke zero halogen
- Available unpainted or to any RAL colour
- Full range of accessories



TBT

DESCRIPTION	CAT. NO.	H	D	L m
1 Compartment	TBT/#	90	90	2



TBTN

90° INTERNAL BEND

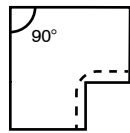

DESCRIPTION	CAT. NO.	H	D
Internal bend	TBTN/#	90	90

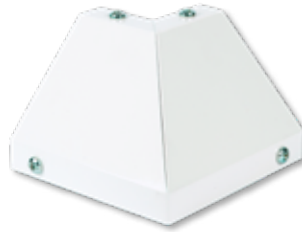

TBTO

90° EXTERNAL BEND

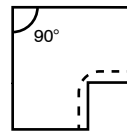

DESCRIPTION	CAT. NO.	H	D
External bend	TBTO/#	90	90



TBEC

END CAPS

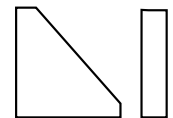

DESCRIPTION	CAT. NO.	H	D
End caps	TBEC/#	90	90

Supplied in pairs.



TBEC

JOINT COUPLER

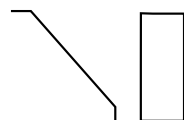

DESCRIPTION	CAT. NO.	H	D
Joint Coupler	TBTC/#	90	90

Supplied in pairs.



TBTDSP

SOCKET PLATES

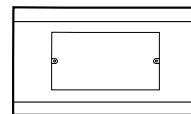

DESCRIPTION	CAT. NO.
Single socket plate	TBTSSP/#
Double socket plate	TBTDSP/#



TBTTSS

SOCKET PLATES

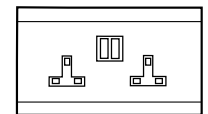

DESCRIPTION	CAT. NO.
Euro 4 module plate	TBTE4M/#
Twin switch socket plate	TBTTSS/#

PEDESTAL BOXES

Pedestal boxes are steel with a powder coated finish as standard and have an earth terminal on the base.

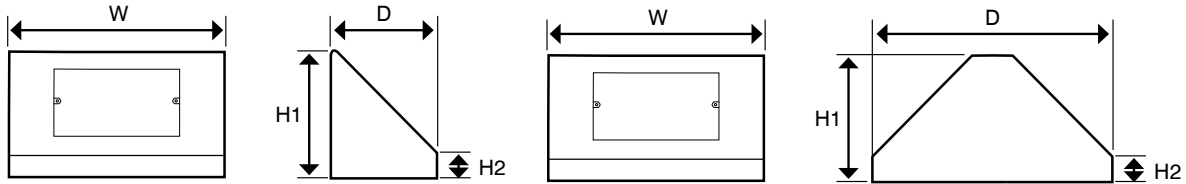

Measurements:
Millimetres (mm)
unless stated
otherwise

/# Colour Suffix:
White: Add /W
Black: Add /B
Galvanised: Add /G



PBX1/W



PBX2/G



PBX3/B



PBX4/W

PEDESTAL BOXES

DESCRIPTION	CAT. NO.	W	D	H1	H2
1 Gang pedestal box	PBX1/#	130	100	90	20
2 Gang pedestal box	PBX2/#	190	100	90	20
2x 1 Gang pedestal box	PBX3/#	190	100	90	20
2 Gang euro pedestal box	PBX1/#	190	100	90	20



PBX44/W



PBX11/W



PBX22/B



PBX33/G

DUAL PEDESTAL BOXES

DESCRIPTION	CAT. NO.	W	D	H1	H2
1 Gang pedestal box x 2	PBX11/#	130	180	90	20
2 Gang pedestal box x 2	PBX22/#	190	180	90	20
2x 1 Gang pedestal box x 2	PBX33/#	190	180	90	20
2 Gang euro pedestal box x 2	PBX44/#	190	180	90	20

BESPOKE MOJ PRISON TRUNKING & CALL POINTS

- Double skinned for extra strength and durability
- Flush or surface mounted
- Anti-ligature design
- Pin Hex button head Security Screws
- Bespoke design
- We also supply hospital call points



KEY FEATURES:

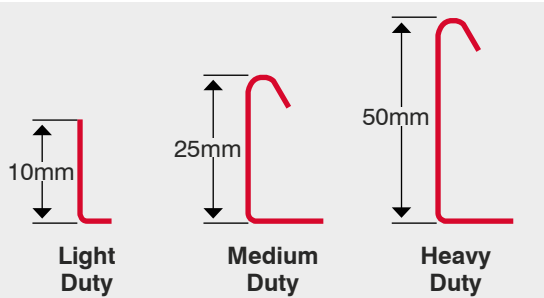

Available widths: 50 - 900mm as standard
Others sizes are available on request

Material

Galvanised

Manufactured from continuously hot dipped zinc coated low carbon steel strip to BSEN 10346: 2015

Magnelis®

Is a flat carbon steel product coated on both sides with a zinc-aluminium-magnesium alloy. This alloy is composed of 93.5% zinc, 3.5% aluminium and 3% magnesium. Thanks to its 3% magnesium content, Magnelis® provides an unprecedented level of surface and cut-edge protection, even in the most hostile environments.

When exposed to the environment, Magnelis® steel forms a very dense zinc-based protective film, unlike galvanised where the film is very porous. This unique dense film is also formed on edges, welds, perforations, and scratches. In case any red rust is present on these uncoated zones, the red rust will gradually be covered by the film also known as self-healing, which is almost impossible for the environment to penetrate.

Finishes

Galv: No suffix
Galv Magnelis: Add suffix /GM
Powder Coated: Add suffix /PC

Supplied

As standard in 3 metre lengths

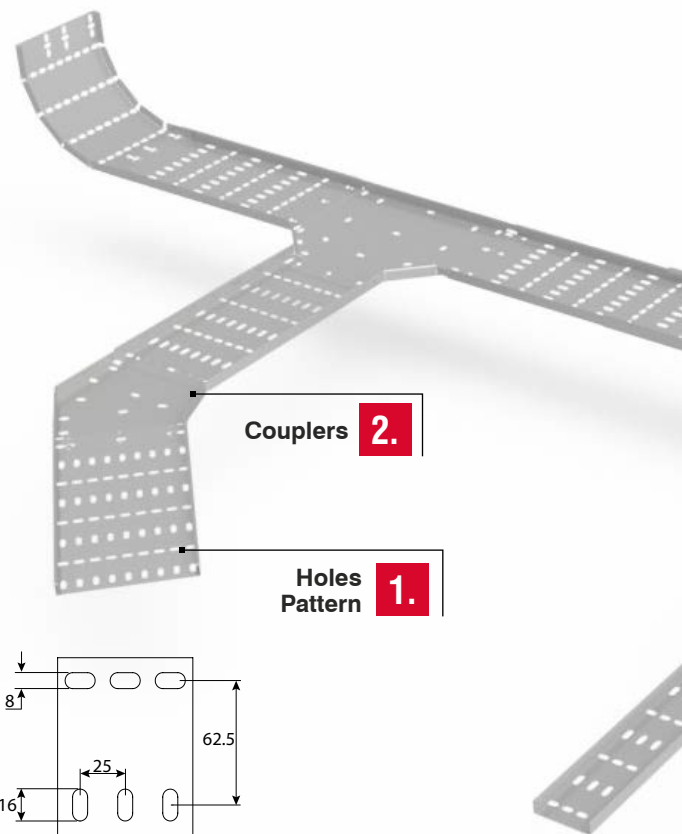

1. Hole Pattern

Designed to provide maximum flexibility for positioning cable ties etc.

2. Integrated Couplers

All accessories have integral couplers, making them quick and easy to install.

3. Reducers

Fit into straight lengths without further drilling, whether they have been cut to length or not.

4. Snap-on Couplers

Are fitted outside tray and are supplied as pairs without fixings

CABLE TRAY

FEATURES:

Tamlex cable tray is available in three types, 10mm straight edge light duty, 25mm return flange medium duty and 50mm heavy duty from 50mm to 900mm widths.

With its unique admiral hole pattern, our cable tray provides installers with maximum flexibility for positioning cable ties without compromising strength.

This strong and durable system has been designed with the installer in mind with a comprehensive range of accessories all with integrated couplers that make it quick and easy to install.

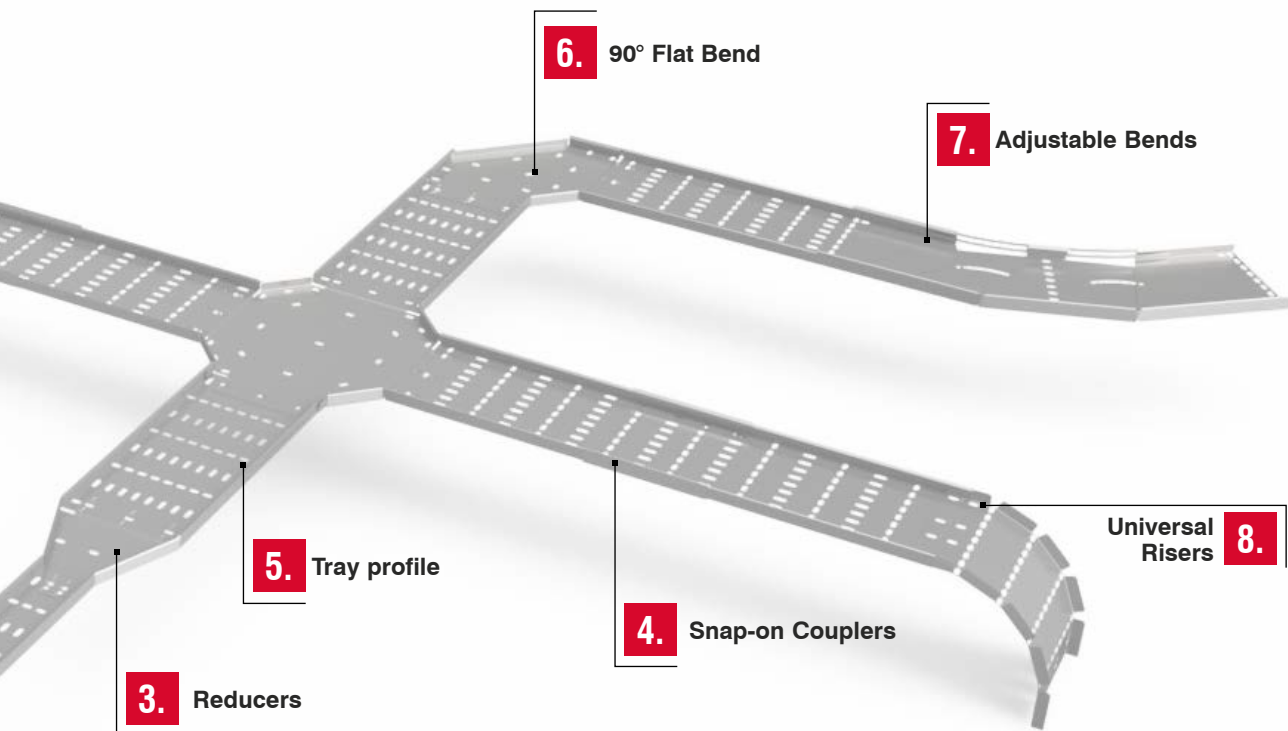

5. Tray profile

Available in light, medium & heavy duty from 50mm - 900mm wide

6. 90° Flat Bend

Bend to length joints secured with M6 x 12 bolts (roofing or pan head), nuts and washers. (TF025).

7. Adjustable Bends

Adjustable flat bends can be adjusted to any angle between 5° and 95°.

8. Universal Risers

Can be used as an inside or outside riser for any angle up to 90°.

CABLE TRAY

Measurements:

Millimetres (mm)
unless stated
otherwise

/## Finish Suffix:

Galv: No /##
Galv Magnelis: /GM
Powder Coated: /PC

FEATURES:

- Standard tray supplied in 3m lengths
- 3 Standard designs of tray to suit individual applications.
- Hole pattern designed to provide maximum flexibility for positioning cable ties without compromising strength.
- Manufactured from continuously hot dipped zinc coated low carbon steel strip to BSEN 10346: 2009.
- Light duty tray has a notched end eliminating the

need for separate couplers.

- Return flange tray couplers do not require the tray to be drilled even when it has been cut.
- Special sizes and designs are available upon request.
- Lid for tray can be made to order.
- Solid tray available upon request.
- Cable tray can be powder coated to any RAL colour.



MCT2

No fixing couplers required on MCT tray.

LIGHT DUTY TRAY 10mm STRAIGHT EDGE

CAT. NO.	W	D	L m
MCT2	50	10	3
MCT3	75	10	3
MCT4	100	10	3
MCT6	150	10	3
MCT9	225	10	3
MCT12	300	10	3
MCT18	450	10	3

Bends, tees and fourways can be site fabricated or purchased.

SPECIAL SIZES
Special sizes and designs are available upon request.

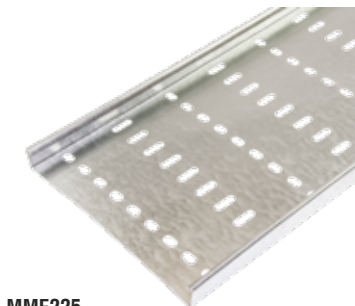

MMF225

MEDIUM DUTY TRAY 25mm DEEP RETURNED FLANGE

CAT. NO.	W	D	L m
MMF/50	50	25	3
MMF/75	75	25	3
MMF/100	100	25	3
MMF/150	150	25	3
MMF/225	225	25	3
MMF/300	300	25	3
MMF/450	450	25	3
MMF/600	600	25	3

SPECIAL SIZES
Special sizes and designs are available upon request.



MHF225

HEAVY DUTY TRAY 50mm DEEP RETURNED FLANGE

CAT. NO.	W	D	L m
MHF/75	75	50	3
MHF/100	100	50	3
MHF/150	150	50	3
MHF/225	225	50	3
MHF/300	300	50	3
MHF/450	450	50	3
MHF/600	600	50	3

SPECIAL SIZES
Special sizes and designs are available upon request.

Sizes above 600mm available upon request.



PMF225-FEC

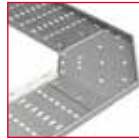

90° FLAT BENDS

LIGHT DUTY CAT. NO.	MEDIUM DUTY CAT. NO.	HEAVY DUTY CAT. NO.	W
PCT50-FE	PMF50-FEC	-	50
PCT75-FE	PMF75-FEC	PHF75-FEC	75
PCT100-FE	PMF100-FEC	PHF100-FEC	100
PCT150-FE	PMF150-FEC	PHF150-FEC	150
PCT225-FE	PMF225-FEC	PHF225-FEC	225
PCT300-FE	PMF300-FEC	PHF300-FEC	300
PCT450-FE	PMF450-FEC	PHF450-FEC	450
-	PMF600-FEC	PHF600-FEC	600



PMF225-FEC45

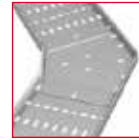

45° FLAT BENDS

LIGHT DUTY CAT. NO.	MEDIUM DUTY CAT. NO.	HEAVY DUTY CAT. NO.	W
PCT50-FE45	PMF50-FEC45	-	50
PCT75-FE45	PMF75-FEC45	PHF75-FEC45	75
PCT100-FE45	PMF100-FEC45	PHF100-FEC45	100
PCT150-FE45	PMF150-FEC45	PHF150-FEC45	150
PCT225-FE45	PMF225-FEC45	PHF225-FEC45	225
PCT300-FE45	PMF300-FEC45	PHF300-FEC45	300
PCT450-FE45	PMF450-FEC45	PHF450-FEC45	450
-	PMF600-FEC45	PHF600-FEC45	600

Measurements:
Millimetres (mm)
unless stated
otherwise

/## Finish Suffix:
Galv: No /##
Galv Magnelis: /GM
Powder Coated: /PC



PMF225-FTC



FLAT TEES

LIGHT DUTY CAT. NO.	MEDIUM DUTY CAT. NO.	HEAVY DUTY CAT. NO.	W
PCT50-FT	PMF50-FTC	-	50
PCT75-FT	PMF75-FTC	PHF75-FTC	75
PCT100-FT	PMF100-FTC	PHF100-FTC	100
PCT150-FT	PMF150-FTC	PHF150-FTC	150
PCT225-FT	PMF225-FTC	PHF225-FTC	225
PCT300-FT	PMF300-FTC	PHF300-FTC	300
PCT450-FT	PMF450-FTC	PHF450-FTC	450
-	PMF600-FTC	PHF600-FTC	600



PMF225-FWC

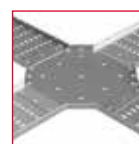

FOURWAYS

LIGHT DUTY CAT. NO.	MEDIUM DUTY CAT. NO.	HEAVY DUTY CAT. NO.	W
PCT50-FW	PMF50-FWC	-	50
PCT75-FW	PMF75-FWC	PHF75-FWC	75
PCT100-FW	PMF100-FWC	PHF100-FWC	100
PCT150-FW	PMF150-FWC	PHF150-FWC	150
PCT225-FW	PMF225-FWC	PHF225-FWC	225
PCT300-FW	PMF300-FWC	PHF300-FWC	300
PCT450-FW	PMF450-FWC	PHF450-FWC	450
-	PMF600-FWC	PHF600-FWC	600

Measurements:
Millimetres (mm)
unless stated
otherwise

Finish Suffix:
Galv: No /##
Galv Magnelis: /GM
Powder Coated: /PC

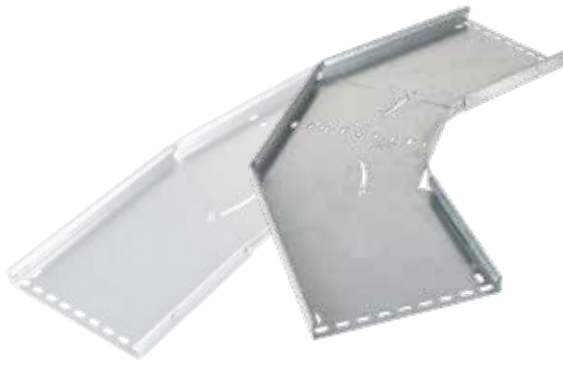

PMF225-ADJ

ADJUSTABLE BENDS

MEDIUM DUTY CAT. NO.	HEAVY DUTY CAT. NO.	W
PMF75-ADJ	PHF75-ADJ	75
PMF100-ADJ	PHF100-ADJ	100
PMF150-ADJ	PHF150-ADJ	150
PMF225-ADJ	PHF225-ADJ	225
PMF300-ADJ	PHF300-ADJ	300
PMF450-ADJ	PHF450-ADJ	450

Sizes above 600 mm available upon request. Bend adjusts from 5° to 95°.

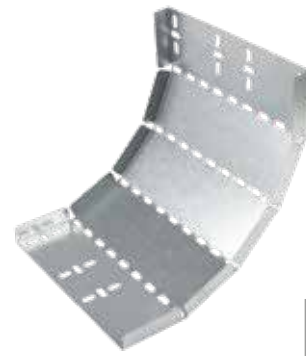

PMF225-UR

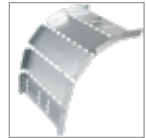

UNIVERSAL RISERS

LIGHT DUTY CAT. NO.	MEDIUM DUTY CAT. NO.	HEAVY DUTY CAT. NO.	W
PCT50-UR	PMF50-UR	-	50
PCT75-UR	PMF75-UR	PHF75-UR	75
PCT100-UR	PMF100-UR	PHF100-UR	100
PCT150-UR	PMF150-UR	PHF150-UR	150
PCT225-UR	PMF225-UR	PHF225-UR	225
PCT300-UR	PMF300-UR	PHF300-UR	300
PCT450-UR	PMF450-UR	PHF450-UR	450
-	PMF600-UR	PHF600-UR	600



PMF225-RC*

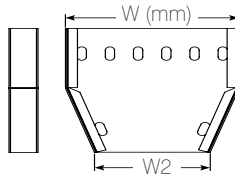

REDUCERS

LIGHT DUTY CAT. NO.	MEDIUM DUTY CAT. NO.	HEAVY DUTY CAT. NO.	W
PCT100-RE*	PMF100-RC*	PHF100-RC*	100
PCT150-RE*	PMF150-RC*	PHF150-RC*	150
PCT225-RE*	PMF225-RC*	PHF225-RC*	225
PCT300-RE*	PMF300-RC*	PHF300-RC*	300
PCT450-RE*	PMF450-RC*	PHF450-RC*	450
-	PMF600-RC*	PHF600-RC*	600

When ordering tray reducers, order the larger size using the Cat. No.

* - The smaller size (W2) must be specified from 75mm to 450mm (e.g. PMF300-RC225).



CABLE TRAY LIDS

PMF/225LID

MEDIUM DUTY CAT. NO.	HEAVY DUTY CAT. NO.	W	L m
PMF/75LID	PHF/75LID	75	3
PMF/100LID	PHF/100LID	100	3
PMF/150LID	PHF/150LID	150	3
PMF/225LID	PHF/225LID	225	3
PMF/300LID	PHF/300LID	300	3
PMF/450LID	PHF/450LID	450	3
PMF/600LID	PHF/600LID	600	3
PMF/LC	PHF/LC	Lid clips	

The cable tray lid is available for PMF and PHF ranges of cable tray and below 75mm and above 600mm upon request. Lid retaining clips sold separately (supplied in pairs).

Tray is transparent for illustrative purposes



PMF/FCP

'SNAP-ON' CABLE TRAY COUPLER

Snap-on couplers are fitted outside tray and are supplied as pairs without fixings. Multiple fixings positions including M6 and slotted.

DESCRIPTION	CAT. NO.	H
Medium duty	PMF/FCP	25
Heavy duty	PHF/FCP	50

Sold in pairs

Measurements:
Millimetres (mm)
unless stated
otherwise

/### Finish Suffix:
Galv: No /##
Galv Magnelis: /GM
Powder Coated: /PC

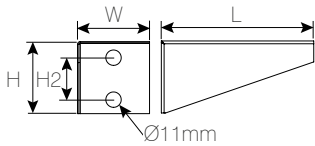

LDS6

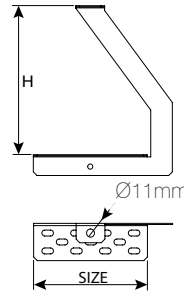

TGH9

LIGHT DUTY SUPPORTS

CAT. NO.	L	W	H	H2
LDS2	50	50	70	30
LDS3	75	50	70	30
LDS4	100	50	70	30
LDS6	150	50	70	30
LDS9	225	50	70	30
LDS12	300	50	70	30

'G' HANGERS

CAT. NO.	SIZE	H
TGH2	50	150
TGH3	75	150
TGH4	100	165
TGH6	150	200
TGH9	225	220
TGH12	300	255

STAND OFF BRACKETS

Can be used reversed as cable tray hangers



STO9

CAT. NO.	W	H	CAT. NO.	W	H
STO2	50	40	STO9	225	40
STO3	75	40	STO12	300	40
STO4	100	40	STO18	450	40
STO6	150	40	STO24	600	40

FASTCONNECT BASKET TRAY

FEATURES:

Tamlex continues to innovate with its enhanced new range of FastConnect basket tray and accessories. Tamlex offers a comprehensive range of basket tray solutions for both power and data installation. The range has been designed to help reduce installation time on-site and therefore save you money. The FastConnect basket tray system is quick and easy to assemble with no tools required thanks to its patented removable coupler which adds strength and rigidity.

Type of material:

METAL (C4D steel wire, UNE-EN 16120-2: 2012)
Ultimate tensile strength: 70 kg/mm²
Yield strength: 60 kg/mm²

Coating:

ELECTRO ZINC (E.Z) in accordance with
UNE-EN 2081: 2010
Zn minimum thickness: 12 μm.



FASTCONNECT BASKET TRAY FEATURES

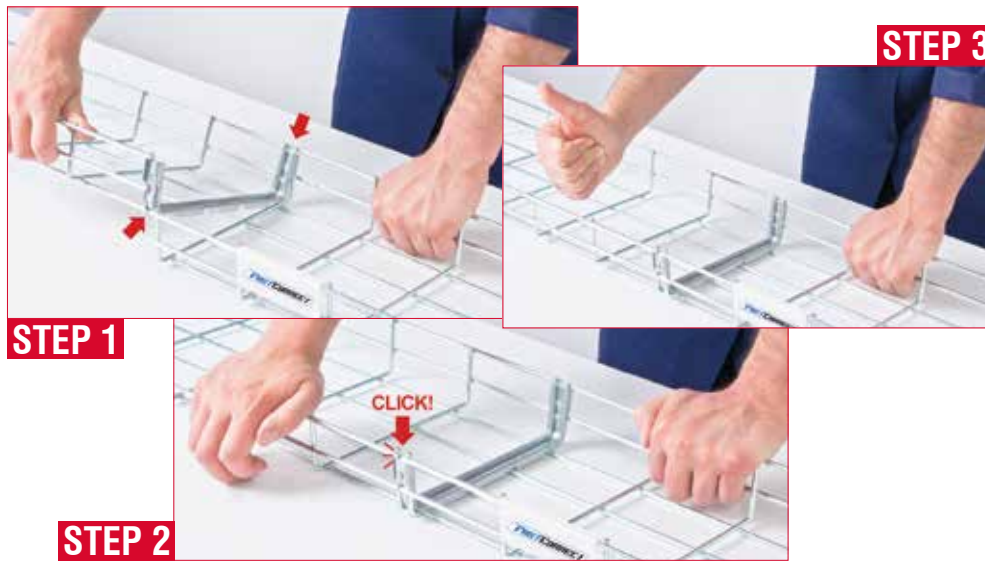

The FastConnect Patented coupler allows for sections of basket tray to be simply joined together without tools in record time.



1. Labour Saving

Strong, lightweight and simple to install



2. Cost Savings

Does not require screws, bolts or other accessories

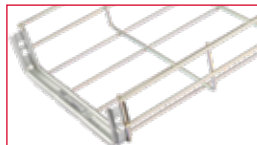

3. Convenience

FastConnect couplers are pre-installed during manufacture



4. Versatile

Coupler can be easily removed and repositioned if necessary

5. Compliance - In accordance with standard BS EN 61537:2007

6. Stronger - Mechanical strength increased up to 22%

7. Safer - Rounded terminations of rods to reduce risk of cable damage

8. Efficient - Substantial improvement in electrical continuity

Tamlex presents its new anti-corrosion coating applied to the basket tray. After a long period of research and development with specialists in the field, the result is a superior galvanic coating. Iridescent, fluoride-free with much higher quality to the previous electro zinc and dichromate electro zinc.

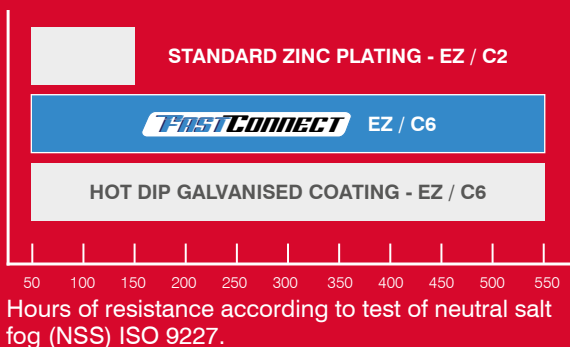

Higher corrosion resistance

550 hours of resistance according to test of neutral salt fog (NSS) ISO 9227.

Higher corrosion rating according to product standard IEC 61537.

Class 6.

Greener coating

The final solution requires less chemicals, with lower levels of discharge of metal in the wastewater. Reduces costs and environmental impact.

BASKET TRAY & SUPPORT BRACKETS

Measurements:
Millimetres (mm)
unless stated
otherwise

**PRE-INSTALLED
FASTCONNECT
COUPLER**

**ROUNDED
TERMINATIONS
IN ALL RODS**

**C6
CORROSION
RESISTANCE**

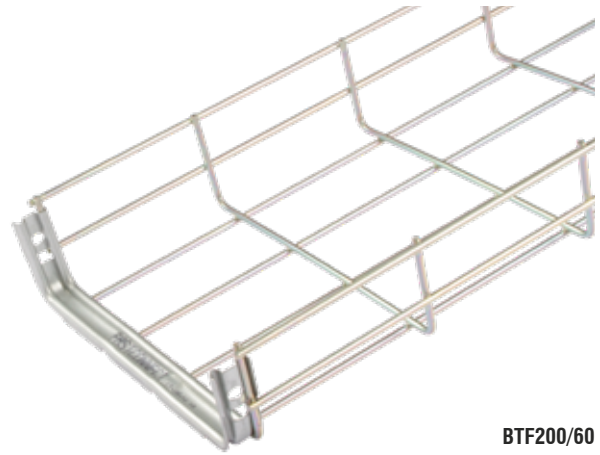

BT/FE200

BASKET TRAY

FastConnect 60mm - 600mm
Basket Tray (3m Length)

- Supplied with pre-installed FastConnect coupler as standard
- 60mm depth as standard
- Steel wire frame 4.0mm diameter
- The FastConnect coupler can be easily removed and repositioned if necessary
- Supplied in 3 metre lengths
- Can be powder coated to any colour

* - Supplied with BT/FX60 couplers

CAT. NO.	W	D	L m
BT/FE60*	60	60	3
BT/FE100	100	60	3
BT/FE150	150	60	3
BT/FE200	200	60	3
BT/FE300	300	60	3
BT/FE400	400	60	3
BT/FE600	600	60	3



35mm BRACKET FOR BTF60/60

FastConnect Basket Tray Fast
Fix Coupler For BTF60/60

DESCRIPTION	CAT. NO.
Fast fix bracket	BT/FX60

Supplied as a pair.

ADDITIONAL BASKET TRAY COUPLERS

The FastConnect Patented
coupler allows for cut sections of
basket tray to be simply joined
together without tools in record
time.

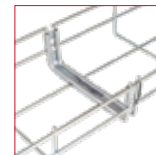

BT/FC100

DESCRIPTION	CAT. NO.
100mm FastConnect basket tray coupler	BT/FC100
150mm FastConnect basket tray coupler	BT/FC150
200mm FastConnect basket tray coupler	BT/FC200
300mm FastConnect basket tray coupler	BT/FC300
400mm FastConnect basket tray coupler	BT/FC400
600mm FastConnect basket tray coupler	BT/FC600

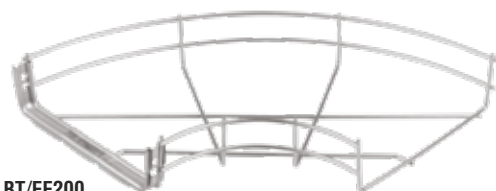

BT/FE200



**PRE-FABRICATED
BENDS**

**C6
CORROSION
RESISTANCE**

PRE-FABRICATED BENDS

FastConnect 100 - 300mm 90° Flat Elbow

CAT. NO.	W	D
BT/FE100	100	60
BT/FE150	150	60
BT/FE200	200	60
BT/FE300	300	60

Supplied with pre-installed FastConnect coupler.

ACCESSORIES

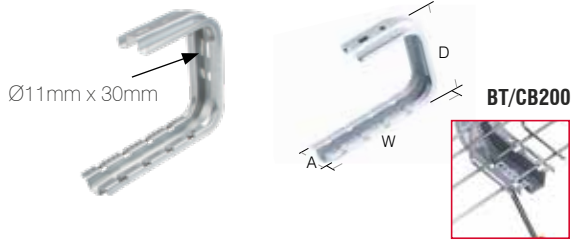

'C' SHAPE SUPPORT BRACKETS

CAT. NO.	W	D	A
BT/CB100	170	215	70
BT/CB150	220	215	70
BT/CB200	270	215	70
BT/CB300	370	215	70
BT/CB400	470	215	70

Distance between supports is of 1.2m and the maximum load is of 10Kg/m.

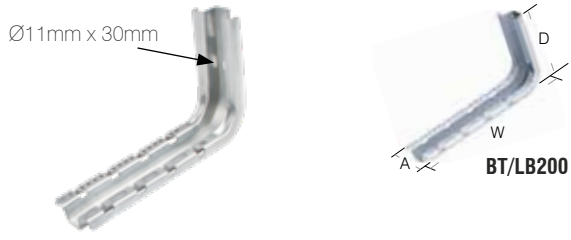

'L' SHAPE SUPPORT BRACKETS

CAT. NO.	W	D	A
BT/LB100	170	155	70
BT/LB150	220	155	70
BT/LB200	270	155	70
BT/LB300	370	165	70
BT/LB400	470	175	70

Distance between supports is of 1.2m and the maximum load is of 10Kg/m.



Measurements:
Millimetres (mm)
unless stated
otherwise



LIGHT DUTY BASKET TRAY BRACKETS

CAT. NO.	W	D
BT/LDS60	60	110
BT/LDS100	100	133

Distance between supports is of 1.2m and the maximum load is of 2Kg/m.

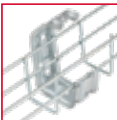

UNION CLAMP ASSEMBLY

DESCRIPTION	CAT. NO.	PACK QTY
Union clamp assembly	BT/UC	50

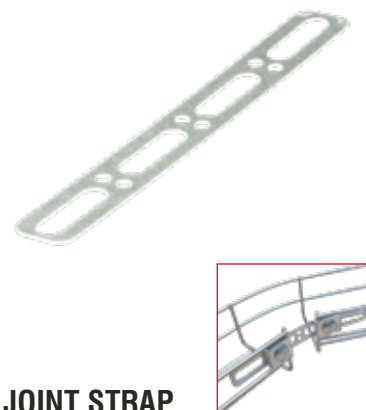

JOINT STRAP

DESCRIPTION	CAT. NO.	PACK QTY
Basket tray joint strap	BT/JS	10

Basket tray joint strap

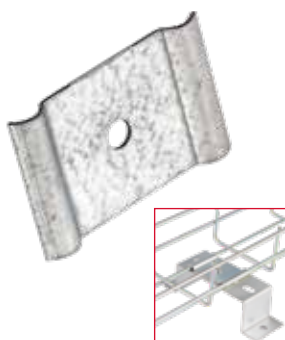
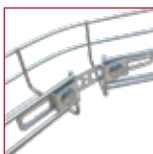

HOLD DOWN CLAMP

DESCRIPTION	CAT. NO.	HOLE Ø
8mm	BT/HD8	9mm
10mm	BT/HD10	11mm

Sold in Singles

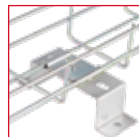

HOLD DOWN SUPPORT

DESCRIPTION	CAT. NO.
Hold down support	BT/HD60

60mm Basket tray only

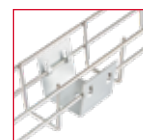

ACCESSORIES

Measurements:
Millimetres (mm)
unless stated
otherwise

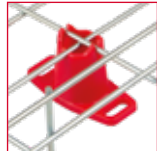

FLOOR FOOT

Plastic support

DESCRIPTION	CAT. NO.
Tray floor foot	BT/FF



CABLE SUPPORT DROP OUT PLATE

Plastic support

DESCRIPTION	CAT. NO.
Cable support drop out plate	BT/CS

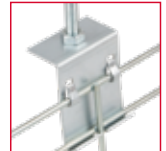

SIDE SUSPENSION CLIP

DESCRIPTION	CAT. NO.
Side suspension clip	BT/SS

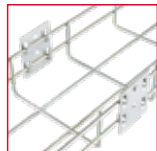

WALL BRACKET

Wall bracket

DESCRIPTION	CAT. NO.
Wall bracket	BT/WB



CHANNEL SUPPORT CLIP

Channel support clip

DESCRIPTION	CAT. NO.
Channel support clip	BT/SC
Not to be used with BTF60/60	

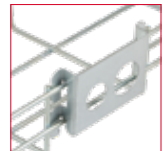

CONDUIT FEED PLATE

Conduit feed plate
20/25mm

DESCRIPTION	CAT. NO.
Conduit feed plate 20/25mm	BT/CA

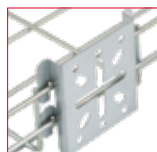

SOCKET BOX ADAPTOR PLATE

Socket box adaptor plate

DESCRIPTION	CAT. NO.
Socket box adaptor plate	BT/SB

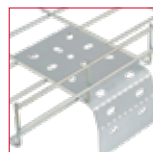

WATERFALL SIDE SUPPORT

Waterfall side support
drop out plate

DESCRIPTION	CAT. NO.
Waterfall side support drop out plate	BT/WP

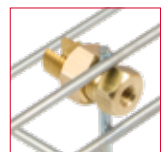

EARTH TERMINAL CLAMP

Earth terminal clamp

DESCRIPTION	CAT. NO.	PACK QTY
Earth terminal clamp	BT/EC	25

Measurements:
Millimetres (mm)
unless stated
otherwise

FILLET / DIVIDER

Simple snap-fit design.
No additional fixing required.

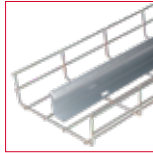

DESCRIPTION	CAT. NO.	Lm
60mm fillet / divider (3m)	BT/FT	3

SUSPENSION FRAMES

Can be used with threaded rod or zip wire to form a trapeze hanger to suspend 100mm to 600mm wide basket tray from the ceiling. Incorporates a slot push fit design for speedy fitting.

Rod not included.

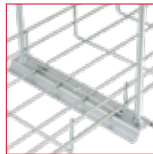

BT/SF200

DESCRIPTION	CAT. NO.	W
100mm FastConnect suspension frame	BT/SF100	150
150mm FastConnect suspension frame	BT/SF150	200
200mm FastConnect suspension frame	BT/SF200	250
300mm FastConnect suspension frame	BT/SF300	350
400mm FastConnect suspension frame	BT/SF400	450
600mm FastConnect suspension frame	BT/SF600	600



BASKET TRAY LID CLIP

DESCRIPTION	CAT. NO.
Bracket tray lid clip	BT/LC

Supplied as a pair.

PUSH FIT LIDS

- Cover eliminates dirt and dust build-up on cables
- Provides physical protection for cables
- To mount the cover no accessories are needed – fixed by push fit design

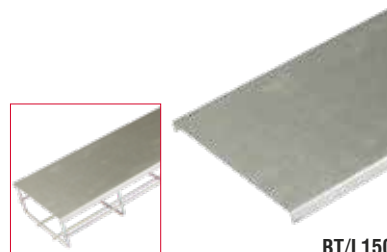

BT/L150

DESCRIPTION	CAT. NO.	W	D
100mm Basket tray 3m push fit lid	BT/L100	100	10
150mm Basket tray 3m push fit lid	BT/L150	150	10
200mm Basket tray 3m push fit lid	BT/L200	200	10
300mm Basket tray 3m push fit lid	BT/L300	300	10
400mm Basket tray 3m push fit lid	BT/L400	400	10
600mm Basket tray 3m push fit lid	BT/L600	600	10

Standard length - 3 metres.

CAVITY FLOOR BOXES

FEATURES:

Single piece metal construction and innovative design enables the latest Tamlex cavity floor box to provide features to assist installation and provide multiple options for the end user.

This exciting range is available in 3 and 4 compartments and in 4 depths ranging from 68mm to 130mm.

A large range of service plates are available separately enabling multiple configurations to be accommodated.



CSB/3 FEATURES

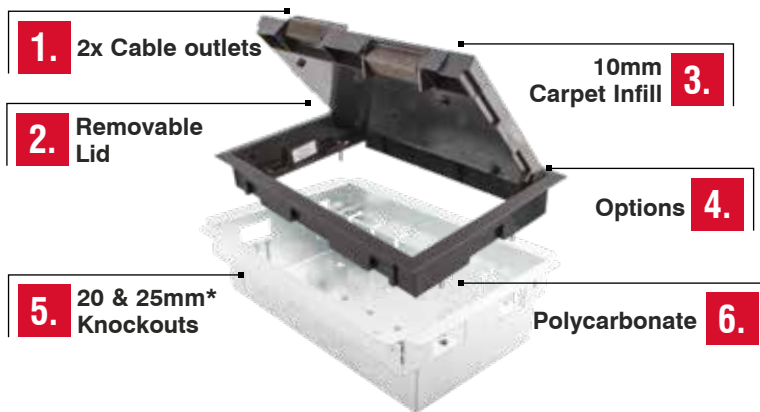

7. Alternative metal trims available designed specifically for high traffic environments such as receptions and universities. (Can be powder coated)

8. Not suitable for wheeled traffic areas

CSB/3/BE shown above



1. 2x Outlets
Cable outlets with sponge foam to prevent ingress



2. Removable Lid
Reversible self-closing lid



3. 10mm Carpet Infill
Reinforced with steel plates with a recessed lid to allow 10mm infill



4. Options
Available in 3 and 4 compartment and in 4 depths ranging from 68mm to 130mm



5. 20 & 25mm* Knockouts
20 & 25mm knockouts to accept flexible conduit. * - 25mm not available on CSB/3/S & FSB3/S



6. Polycarbonate
Durable polycarbonate trim and lid as standard

Different depths available upon request

1. Lift up hinged lid to access the power and data sockets.



2. Plug in the required leads to the available sockets.



3. Close lid and position leads through the hinged access slots.



IMPORTANT: PLEASE NOTE - Service boxes are designed for use in office type environments and should not be installed in main walkways, corridors, gangways or in contact with wheeled traffic.

3 COMPARTMENT SERVICE BOXES



Measurements:
Millimetres (mm)
unless stated
otherwise

Plate Size:
Accepts 85 mm
plates only



CSB3/S

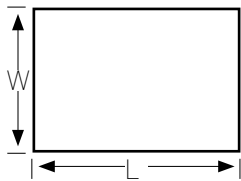

Dimensions:
Length: 320mm
Width: 225mm

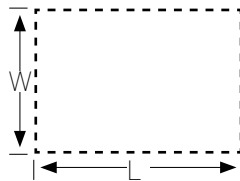

Floor cut-out size:
Length: 305mm
Width: 205mm

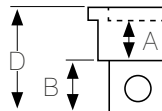
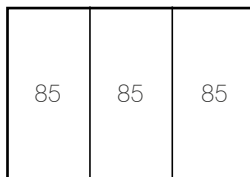

CAVITY BOXES

CAT. NO.	KNOCKOUTS	D	A	B
CSB3/S	20mm	68*	24	23
CSB3/BE	20/25mm	87	24	42
CSB3	20/25mm	100	45	35
CSB3/ED	20/25mm	130	45	65

* - Customer notice 68mm depth service boxes have restrictive cable capacity

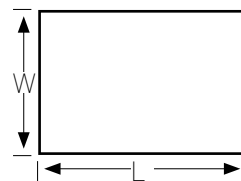

Dimensions:
Length: 320mm
Width: 225mm

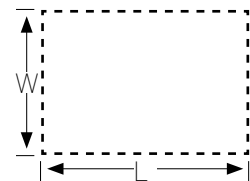

Floor cut-out size:
Length: 305mm
Width: 205mm

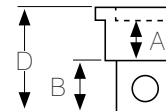
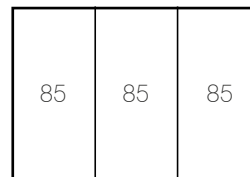

SCREED

CAT. NO.	KNOCKOUTS	D	A	B
FSB3/S	20mm	68*	24	23

For use with 20mm conduit.

3 COMPARTMENT SERVICE BOX PLATES

FEATURES:

Plates are manufactured in plastic coated steel (blue) with folded edges to give additional strength.

The 68mm cavity and screeded service boxes should only be fitted with flush / panel mounted

sockets (C2GS) due to the limited depth.

(X) Not suitable for 68mm deep service boxes due to restrictive cable capacity

Measurements:
Millimetres (mm)
unless stated
otherwise

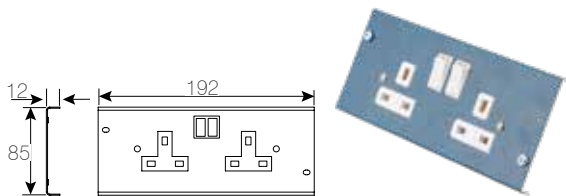

DESCRIPTION	CAT. NO.	L	W	D
Twin switched socket	C2GS	192	85	12

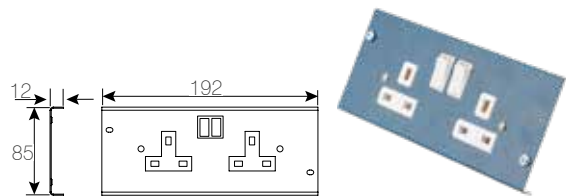

DESCRIPTION	CAT. NO.	L	W	D
Twin switched socket dual earth	C2GS/DE	192	85	12

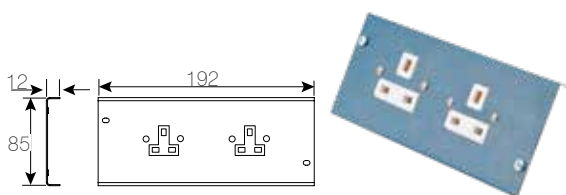

DESCRIPTION	CAT. NO.	L	W	D
2x Unswitched sockets	C2US	192	85	12

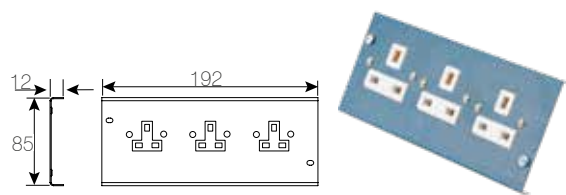

DESCRIPTION	CAT. NO.	L	W	D
3x Unswitched sockets	C3US	192	85	12

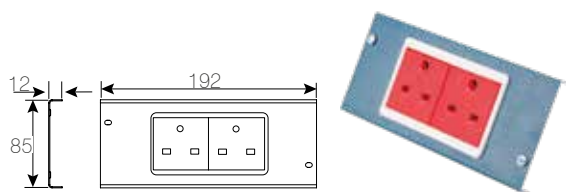

DESCRIPTION	CAT. NO.	L	W	D
2x Non standard sockets	C2USNS	192	85	12

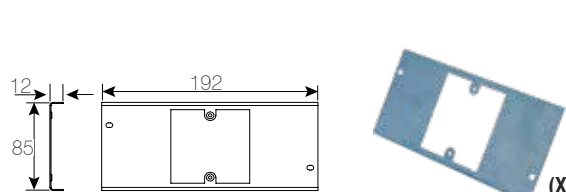

DESCRIPTION	CAT. NO.	L	W	D
1x1 Gang outlet	CPP04/1	192	85	12

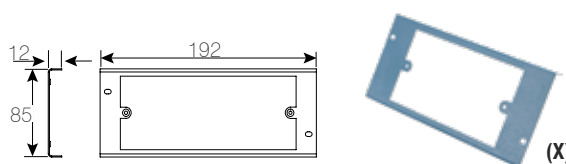

DESCRIPTION	CAT. NO.	L	W	D
2 Gang outlet	CPP04/D	192	85	12

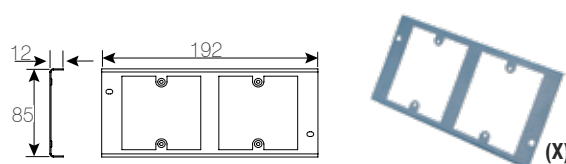

DESCRIPTION	CAT. NO.	L	W	D
2x1 Gang outlets	CPP04/2	192	85	12

3 COMPARTMENT SERVICE BOX PLATES

Measurements:
Millimetres (mm)
unless stated
otherwise

FEATURES:

Plates are manufactured in plastic coated steel (blue) with folded edges to give additional strength.

The 68mm cavity and screeded service boxes should only be fitted with flush / panel mounted

sockets (C2GS) due to the limited depth.

(X) Not suitable for 68mm deep service boxes due to restrictive cable capacity

VOICE & DATA

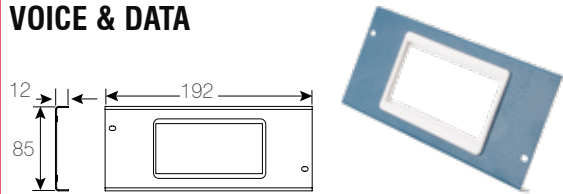

DESCRIPTION	CAT. NO.	L	W	D
Accept 25x50mm & 50x50mm modules	CDE345	192	85	12

BLANK PLATE

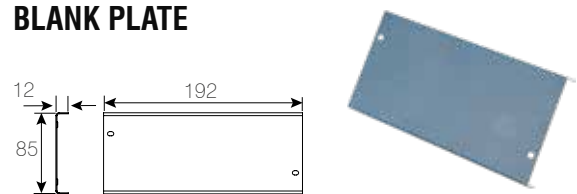

DESCRIPTION	CAT. NO.	L	W	D
Blank plate	CBP	192	85	12

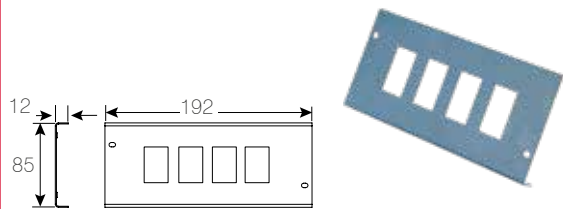

DESCRIPTION	CAT. NO.	L	W	D
4x RJ45/LJ6C (37x22mm)	CPP06	192	85	12

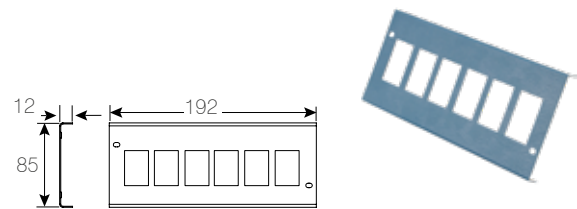

DESCRIPTION	CAT. NO.	L	W	D
6x RJ45/LJ6C (37x22mm)	CPP06/6	192	85	12

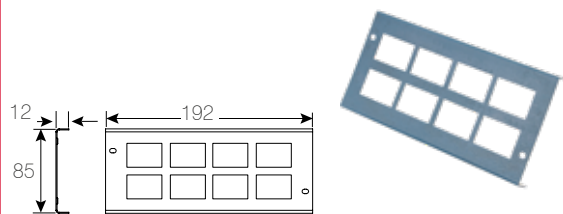

DESCRIPTION	CAT. NO.	L	W	D
8x RJ45/LJ6C (37x22mm)	CPP06/8	192	85	12

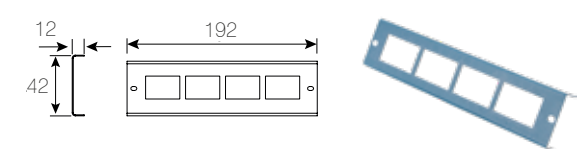

HALF PLATES

HCPP01

DESCRIPTION	CAT. NO.	L	W	D
Half plate 4x RJ45/LJ6C	HCPP01	192	42	12
Half plate blank	HCBP	192	42	12

For use with C3GS only.

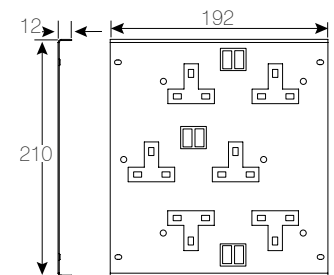

DESCRIPTION	CAT. NO.	L	W	D
3x Twin switched sockets	C3GS	192	210	12

4 COMPARTMENT SERVICE BOX

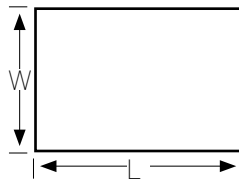

Dimensions:
Length: 320mm
Width: 225mm

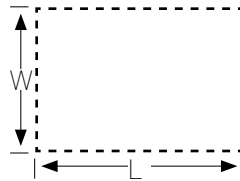

Floor cut-out size:
Length: 305mm
Width: 205mm

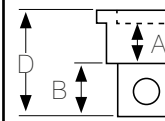
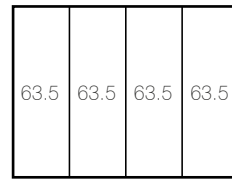

Measurements:
Millimetres (mm)
unless stated
otherwise

CAVITY BOXES

4 compartment boxes have 4 equal compartments 63.5mm wide. Use with 'SL' plates only.

CAT. NO.	KNOCKOUTS	D	A	B
CSB4/SL	20mm	68	24	23

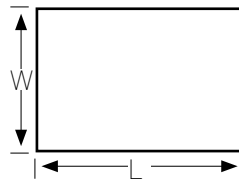

Dimensions:
Length: 320mm
Width: 225mm

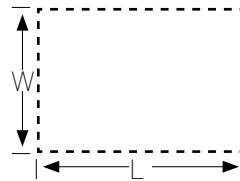

Floor cut-out size:
Length: 305mm
Width: 205mm

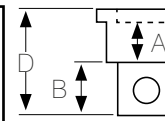
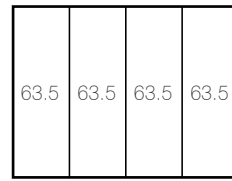

SCREED

For use with 20mm conduit.

4 compartment boxes have 4 equal compartments 63.5mm wide. Use with 'SL' plates only.

CAT. NO.	KNOCKOUTS	D	A	B
FSB4/SL	20mm	68	24	23

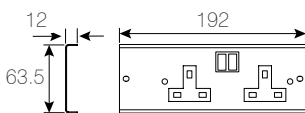

DESCRIPTION	CAT. NO.	L	W	D
Twin switched socket - Slimline	C2GS/SL	192	63.5	12

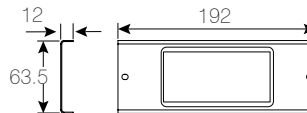

DESCRIPTION	CAT. NO.	L	W	D
Accept 25x50mm & 50x50mm modules - Slimline	CDE345/SL	192	63.5	12

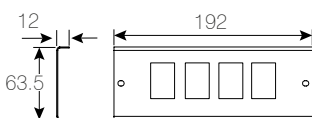

DESCRIPTION	CAT. NO.	L	W	D
Accept 4x RJ45/LJ6C 37x22mm - Slimline	CPP06/SL	192	63.5	12

BLANK PLATE

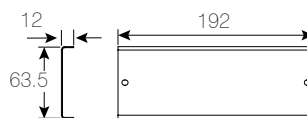

DESCRIPTION	CAT. NO.	L	W	D
Blank plate - Slimline	CBP/SL	192	63.5	12



CST68



CST100



CSL



CF

SERVICE BOX REPLACEMENT PARTS

DESCRIPTION	CAT. NO.
45mm Deep trim to fit 68/87mm service boxes	CST68
65mm Deep trim to fit 100/130mm service boxes	CST100
Service box lid (10mm recess)	CSL
Cable flap	CF

MODULAR FLUSH SCREED TRUNKING

FEATURES:

One of Tamlex's strengths as a manufacturer is the ability to react to individual customer requirements. Whether the requirement is for a range of standard products to be delivered direct to a site address or it is for a complete installation kit of bespoke manufactured products Tamlex can and has met this demand.

- 3 segmented compartments to accommodate service boxes.
- Reinforced lid allows foot traffic.
- Service boxes can be fitted after trunking is installed.
- Supplied in standard 2m lengths with couplers.

Screed trunking must be installed on a solid foundation and completely supported by a screed ribbon.



MODULAR TRUNKING FEATURES

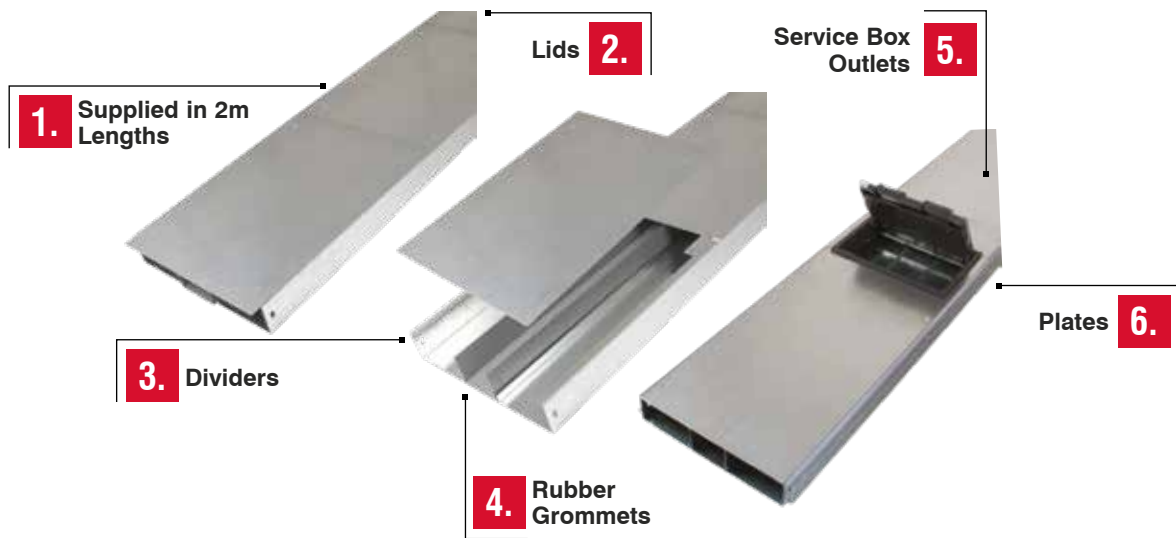

1. Supplied in 2m Lengths
Supplied in 2m lengths with 3 lids to accommodate service outlets



2. Lids
Reinforced lid allows foot traffic

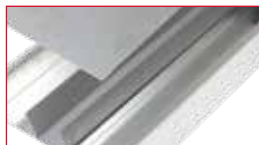

3. Dividers
Removable dividers provide greater flexibility when fitting service outlets



4. Rubber Grommets
Supplied to be site fitted to increase stability and reduce lid deflection



5. Service Box Outlets
Can be fitted in place of any 0.5m lid section anywhere in the trunking length



6. Plates
Power, voice and data plates available to accommodate customer's needs

SERVICE BOX OUTLET FITTING

1. Select any lid position.



2. Remove lid & fillet.



3. Drop in service outlet box.



Service boxes can be positioned/repositioned anywhere on trunking.

MODULAR FLUSH SCREED TRUNKING

Measurements:
Millimetres (mm)
unless stated
otherwise

MODULAR FLUSH SCREED TRUNKING LENGTH

Screed trunking must be installed on a solid foundation and completely supported by a screed ribbon.

- 3 segregated compartments.
- Reinforced lid to allow foot traffic.
- Service boxes can be fitted after trunking is installed.
- Internal fillets have rubber gasket to increase stability and reduce lid deflection.

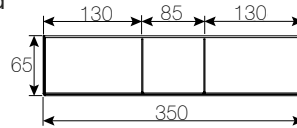

CAT. NO.	W	D	L m
FSM350/65/3	350	65	2

Supplied in standard 2m lengths with 4 x 0.5m lid sections and joining coupler. Rubber grommet supplied to be site fitted.

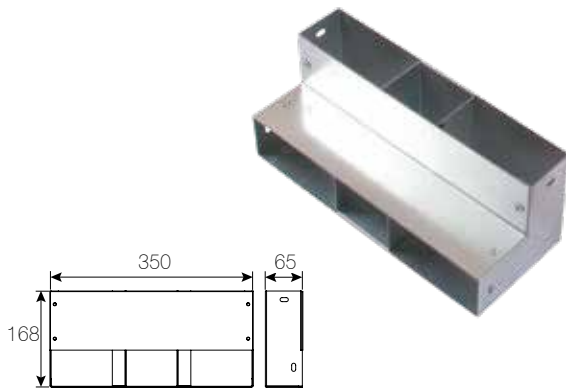

RISER BEND

CAT. NO.	W	H
FSIRM350	350	65

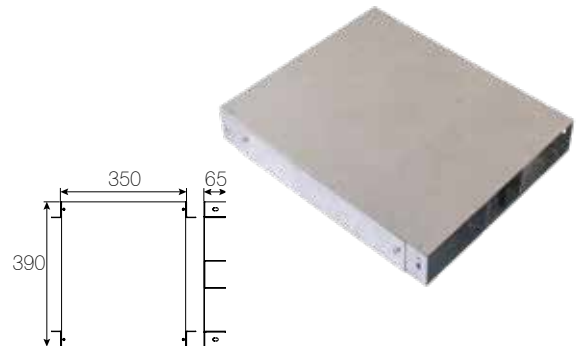

INTERSECTION

CAT. NO.	W	H
FSJM350	350	65

Intersection to be used as Flat Bend, Tee and Fourway.

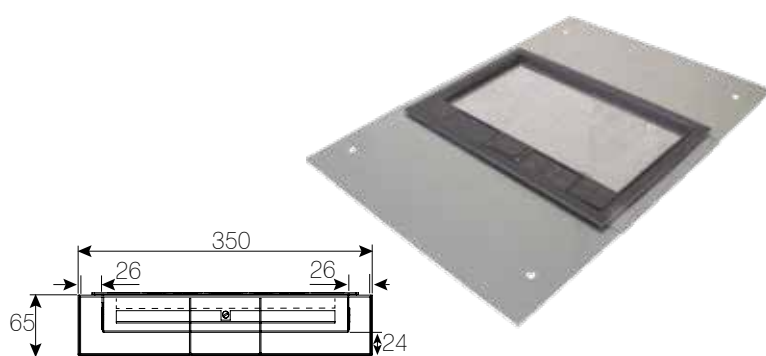

SERVICE BOX OUTLET

CAT. NO.	W	H
FSBM3	350	65

Suitable for modular flush screed trunking only.



STOP END

CAT. NO.	W	H
FSEM350	350	65

DID YOU KNOW?

Service box outlets can be fitted in place of any 0.5m lid section anywhere in the trunking length, even after the trunking is fitted

FLUSH SCREED TRUNKING

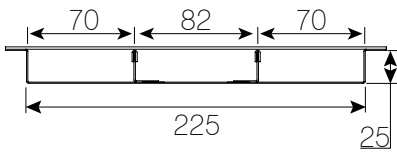

Measurements:
Millimetres (mm)
unless stated
otherwise

FLUSH SCREED TRUNKING LENGTH

- 3 segregated compartments.
- Shallow 25mm deep trunking profile.
- Reinforced lid to allow foot traffic.
- Manufactured from continuously hot dipped zinc coated low carbon steel strip to BSEN 10346:2009.
- Fillets have gasket strip fitted to increase stability and reduce lid deflection.
- Intersections are 55mm deep to allow the maximum cable capacity throughout the system.

CAT. NO.	W	D	L m
FS225/25/3	225	25	2

2 m length complete with 2 x 1m lids & coupler.
Jacking bolts need to be ordered separately (M6 x 40mm)
Cat. No. TF005.
Screed trunking must be installed on a solid foundation
and completely supported by a screed ribbon.

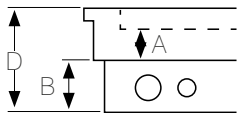

FLUSH SCREED TRUNKING SERVICE BOX

CAT. NO.	W	D	A	B
FSB3	220	69	24	23

Suitable for Tamlex flush screed trunking only.



INTERSECTION

CAT. NO.	W	D
FSJ/93	225	55

Intersection to be used as flat bend, tee and fourway.

INTERSECTION

Intersection - Flat bend.

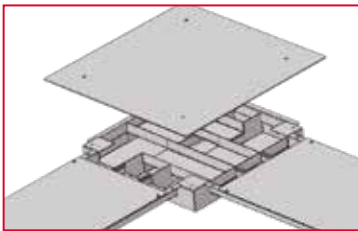

Intersection - Tee.

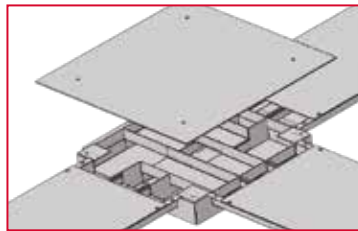

Intersection - Fourway.

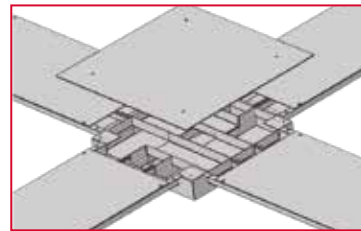

RISER BEND

CAT. NO.	W	H
FSIR/3	225	25

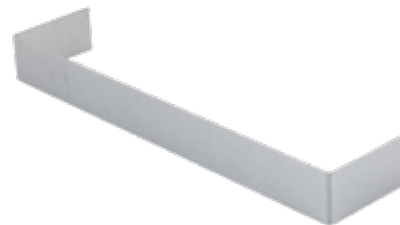

STOP END

CAT. NO.	W	H
FSE/91	225	25

SPECIAL FABRICATION

We are a service driven business; that's what our business was built on. We aim to give our clients fantastic prices and quality whilst meeting the tight deadlines required by today's industry. We have a vital edge over our competition with our ability to turn around bespoke products quickly.

This comes from our investment in technology and people, together with robust processes and efficient systems. We're also committed to going that extra mile to deliver high quality on time and exceed customer expectations.

Need something special or bespoke?

If you need specialist or bespoke products or you can't find the product specification you need, simply contact the Tamlex factory for further information: sales@tamlex.co.uk

**CNC PUNCHING
CNC DESIGN
POWDER COATED
SPOT WELDING
STRUT CUT TO LENGTH
CUTTING
FORMING
PRESSING
ASSEMBLY**

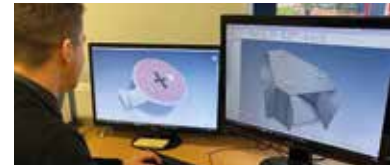
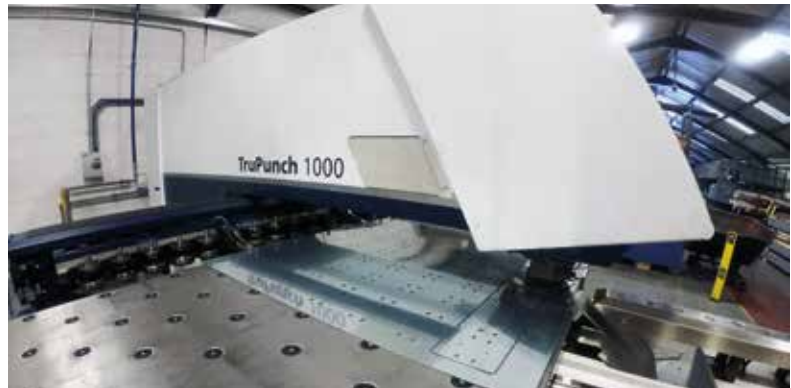

SPECIALIST PAINT FINISHES

Tamlex cable tray in addition to other Tamlex product ranges are available in specific paint finishes required by the customer.



SOLID CABLE TRAY

The solid cable tray is available in 25mm and 50mm deep and available from 75mm to 600mm wide upon request.

FEATURES:

The Tamlex range of switch & socket boxes are available in a wide range of styles and sizes for any domestic, commercial and industrial installations.

- Switch & socket boxes conform to BS 4662.
- Boxes supplied with one fixed lug & one adjustable lug.

- Manufactured from continuously hot dipped zinc coated low carbon steel strip to BSEN 10346: 2009.
- Switch and socket boxes are fitted with brass pillar earth terminals.

Measurements:
Millimetres (mm)
unless stated
otherwise

1 GANG SWITCH & SOCKET BOXES

T1G16 has 1 fixed lug and 1 adjustable lug.
All boxes have 3 fixed lug and 1 adjustable lug.

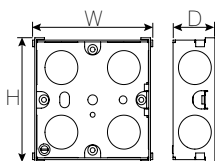

T1G25

CAT. NO.	D	W	H	KNOCKOUTS		
				25x12.5mm	20mm	25mm
T1G16	16	72	72	3	-	-
T1G25	25	72	72	-	12	-
T1G35	35	72	72	-	11	-
T1G47	47	72	72	-	8	3

2 GANG SWITCH & SOCKET BOXES

All boxes have 1 fixed lug and 1 adjustable lug.

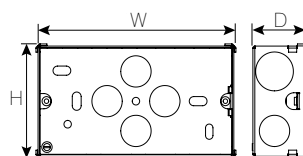

T2G35

CAT. NO.	D	W	H	KNOCKOUTS	
				20mm	25mm
T2G25	25	132	72	16	-
T2G35	35	132	72	13	3
T2G47	47	132	72	10	6

DUAL SWITCH & SOCKET BOXES

T2G35DUAL has 2x single socket apertures and dual fixed lugs.



T2G35DUAL

CAT. NO.	D	W	H	K/O 20mm
T2G35DUAL	35	156	72	16

ADAPTABLE BOXES

Measurements:
Millimetres (mm)
unless stated
otherwise

FEATURES:

- Manufactured from continuously hot dipped zinc coated low carbon steel strip to BSEN 10346: 2009.
- Tamlex non-standard adaptable boxes can be

manufactured in various sizes.

- Adaptable boxes can also be supplied without knockouts (plain) or with knockouts as standard.
- The boxes can be painted upon request.
- Special sizes available.
- 20mm Knockout holes

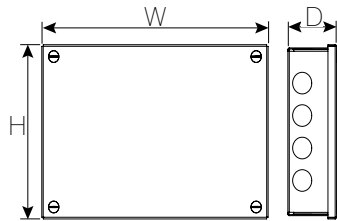

GALVANISED ADAPTABLE BOXES

Available in a wide range of styles and sizes for any domestic, commercial and industrial installations.



K333G

CAT. NO.	W	H	D
K331G	75	75	37
K332G	75	75	50
K333G	75	75	75



K442G

CAT. NO.	W	H	D
K441G	100	100	37
K442G	100	100	50
K443G	100	100	75
K444G	100	100	100



K643G

CAT. NO.	W	H	D
K632G	150	75	50
K642G	150	100	50
K643G	150	100	75
K662G	150	150	50



K664G

CAT. NO.	W	H	D
K663G	150	150	75
K664G	150	150	100
K666G	150	150	150



K962G

CAT. NO.	W	H	D
K962G	225	150	50
K963G	225	150	75
K993G	225	225	75

FEATURES:

- Galvanised steel - Class 4.
- Supplied in 3.00 and 3.75 metre lengths.
- Hot dipped galvanised internally and externally.

- All conduit conforms to BS EN 61386-1: 2008 + A1: 2018.
- All conduit have threaded ends with one end fitted with a coupler.

Measurements:
Millimetres (mm)
unless stated
otherwise

CLASS 4 POST HOT DIPPED GALVANISED

20mm Class 4 Hot Dipped Metal Galvanised Steel Metal Conduit

- All conduit have threaded ends with one end fitted with a coupler



CAT. NO.	DIA	L m	L PER BUNDLE
SGC20-3	20	3.00	8
SGC20	20	3.75	8

CLASS 4 POST HOT DIPPED GALVANISED

25mm Class 4 Hot Dipped Metal Galvanised Steel Metal Conduit

- All conduit have threaded ends with one end fitted with a coupler



CAT. NO.	DIA	L m	L PER BUNDLE
SGC25-3	25	3.00	8
SGC25	25	3.75	8

STRUT FRAMEWORK

Our strut line allows us to manufacture our Tamlex strut in house, including punching the holes, cutting it to lengths required by our customers, and to incorporate the serrated edge of our strut channels that provides a better grip between our channel and nut.

Material

- Manufactured to BS 6946: 1988
- Serrated internal lip gives superior grip for fasteners
- Manufactured from structural grade continuously hot dipped zinc coated low carbon steel Strip to BS EN 10346: 2015
- Available in 2.5mm & 1.5mm thickness
- 3m or 6m lengths.



DIMENSIONS

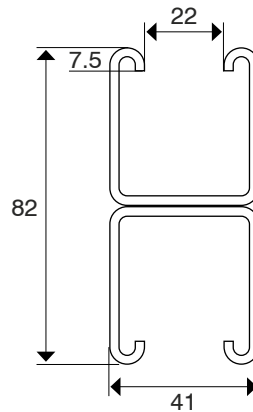
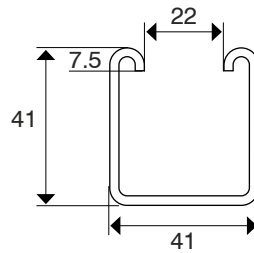
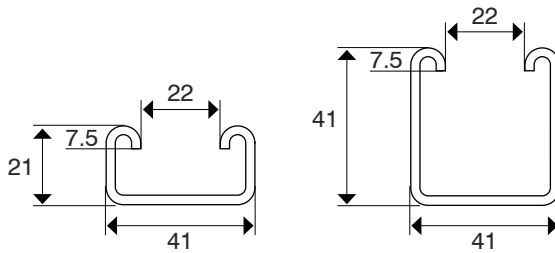

- Thicknesses: 2.5mm or 1.5mm
- Lengths: 3m or 6m

HOLE DIMENSIONS

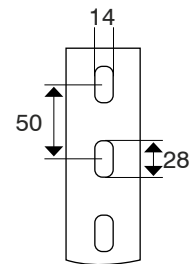

SERRATED EDGE

The serrated edge of our Tamlex strut channel provides a better grip between the channel and nut. The serrated "teeth" are compatible with the grooves in sliding nuts, beam clamps, fasteners, and channel brackets, forming a complete strut support system.



MARKINGS

In accordance to BS 6946:1988 our strut is marked at regular intervals with the Tamlex name as the manufacturer and the associated standard. This happens during the manufacturing process on-site. Accessories are marked via labels on packaging.



Measurements:
Millimetres (mm)
unless stated
otherwise

PLAIN STRUT

- Rigid construction for a wide variety of applications
- Manufactured from structural grade continuously hot dipped zinc coated low carbon steel strip to BSEN 10346: 2009
- Channel available in both 1.5mm and 2.5mm thick
- Supplied in 3m or 6m lengths
- Wide range of external brackets available for use with strut frame work



TS21P-3



TS41P-3

CAT. NO.	H	W	L m	GAUGE
TS21P-3	21	41	3	2.5
TS21P-6	21	41	6	2.5
TS41P-3	41	41	3	2.5
TS41P-6	41	41	6	2.5

SLOTTED STRUT

- Rigid construction for a wide variety of applications
- Manufactured from structural grade continuously hot dipped zinc coated low carbon steel strip to BSEN 10346: 2009
- Channel available in both 1.5mm and 2.5mm thick
- Supplied in 3m or 6m lengths
- Wide range of external brackets available for use with strut frame work



TS21S-3



TS41S-3

CAT. NO.	H	W	L m	GAUGE
TS21S-3	21	41	3	2.5
TS21S-6	21	41	6	2.5
TS41S-3	41	41	3	2.5
TS41S-6	41	41	6	2.5

BACK TO BACK

- Rigid construction for a wide variety of applications
- Manufactured from structural grade continuously hot dipped zinc coated low carbon steel strip to BSEN 10346: 2009
- Channel available in both 1.5mm and 2.5mm thick
- Supplied in 3m lengths
- Wide range of external brackets available for use with strut frame work



TS21P-3B2B



TS41P-3B2B

CAT. NO.	H	W	L m	GAUGE
TS21P-3B2B	42	41	3	2.5
TS41P-3B2B	82	41	3	2.5

DID YOU KNOW?

Tamlex strut framework can be supplied pre-cut to any length to suit customer requirements.



STRUT FRAMEWORK

Measurements:

Millimetres (mm)
unless stated
otherwise

Note: TA103-*
Cover will not fit light
duty strut

LIGHT GAUGE PLAIN STRUT

- Rigid construction for a wide variety of applications
- Manufactured from structural grade continuously hot dipped zinc coated low carbon steel strip to BSEN 10346: 2009
- Channel available in both 1.5mm and 2.5mm thick
- Supplied in 3m or 6m lengths
- Wide range of external brackets available for use with strut frame work



TS21P-3LG



TS41P-3LG

CAT. NO.	H	W	L m	GAUGE
TS21P-3LG	21	41	3	1.5
TS41P-3LG	41	41	3	1.5

LIGHT GAUGE SLOTTED STRUT

- Rigid construction for a wide variety of applications
- Manufactured from structural grade continuously hot dipped zinc coated low carbon steel strip to BSEN 10346: 2009
- Channel available in both 1.5mm and 2.5mm thick
- Supplied in 3m or 6m lengths
- Wide range of external brackets available for use with strut frame work



TS21S-3LG



TS41S-3LG

CAT. NO.	H	W	L m	GAUGE
TS21S-3LG	21	41	3	1.5
TS41S-3LG	41	41	3	1.5

DID YOU KNOW?

Tamlex strut framework can be supplied pre-cut to any length to suit customer requirements.





TF022

Measurements:
Millimetres (mm)
unless stated
otherwise

THREADED RODS

Our threaded bar is a type of fastener that is commonly known as all-thread studding, threaded rod or screwed rod. It is a 3-metre length of bar that is fully threaded throughout its entire length, allowing it to be used in a wide range of applications where standard bolts are not long enough.

One of the benefits of using threaded bar is that it can be cut down to make bolts of the desired length, making it a cost-effective solution for those who require custom-sized bolts. Additionally, threaded bars can be extended with stud connector nuts, providing an even greater level of versatility in their use.

Our threaded bar is available in zinc-plated steel grade 4.6 mild steel, which is a material known for its durability and strength. This makes our threaded bar a reliable choice for a range of applications, including construction, manufacturing, and DIY projects.

- Threaded bar / studding for use with Tamlex strut framework systems.
- Threaded bar can be used for various other applications.
- Material: steel
- Bright Zinc Plate (BZP)

DESCRIPTION	CAT. NO.	Dia	Lm
M6 x 3m Long	TF021	6	3m
M8 x 3m Long	TF022	8	3m
M10 x 3m Long	TF023	10	3m
M12 x 3m Long	TF024	12	3m

FULLY OR PART ASSEMBLED (PRE-FABRICATED) TRAPEZE SYSTEMS

This service saves contractors time and money by handling the cutting and assembly at our factory. We then deliver it direct to site.

3 versions

1 tier, 2 tier or 3 tier

Available in 4 standard widths

0-500mm | 501-1000mm | 1001-1500mm | 1501-2000mm

Supplied With

Strut cut to length, threaded rod, stop ends and fixing kit.



ACCESSORIES

Measurements:
Millimetres (mm)
unless stated
otherwise



SQUARE PLATES

TB101-10

DESCRIPTION	CAT. NO.
For use with M6 rod, 8mm hole	TB101-6
For use with M8 rod, 10mm hole	TB101-8
For use with M10 rod, 12mm hole	TB101-10
For use with M12 rod, 14mm hole	TB101-12

Pack quantity: 100 per pack.



FLAT PLATES

TB104

DESCRIPTION	CAT. NO.
For use with M12 rod, 2 x 14mm hole	TB102
For use with M12 rod, 3 x 14mm hole	TB103
For use with M12 rod, 4 x 14mm hole	TB104
For use with M12 rod, 5 x 14mm hole	TB105

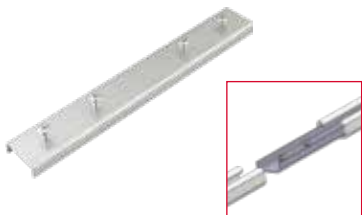

INTERNAL COUPLERS

TA105-21

CAT. NO.	SIZE
TA105-21	21 x 41
TA105-41	41 x 41

Internal couplers c/w fixing screws.

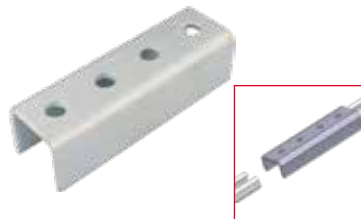

EXTERNAL COUPLERS

TB202

CAT. NO.	SIZE
TB201	21 x 41
TB202	41 x 41

Use with channel nuts.



2 HOLE RIGHT ANGLE BRACKET

CAT. NO.	SIZE
TB140	40 x 40



3 HOLE RIGHT ANGLE BRACKET

CAT. NO.	SIZE
TB142	100 x 40

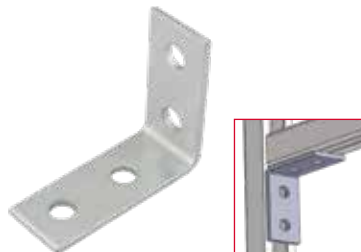

4 HOLE RIGHT ANGLE BRACKET

CAT. NO.	SIZE
TB144	100 x 80

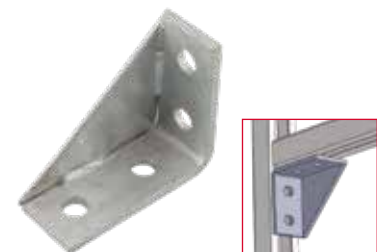

4 HOLE GUSSET SUPPORT BRACKET

CAT. NO.	SIZE
TB145	100 x 80

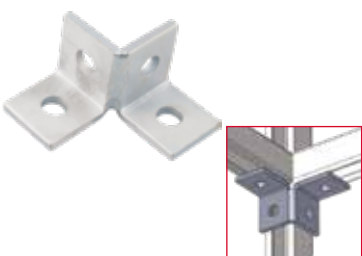

DOUBLE CORNER BRACKET

DESCRIPTION	CAT. NO.
4 Hole double corner bracket	TB146

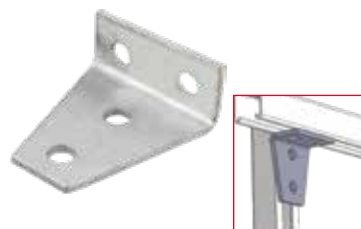

4 HOLE GUSSET L-SHAPE BRACKET

DESCRIPTION	CAT. NO.
4 Hole 'L' shape gusset bracket	TB147



135° ANGLE BRACKET

DESCRIPTION	CAT. NO.
2 Hole 135° bracket	TB148

Measurements:
Millimetres (mm)
unless stated
otherwise



45° ANGLE BRACKET

DESCRIPTION	CAT. NO.
2 Hole 45°	TB149



DOUBLE TEE BRACKET

DESCRIPTION	CAT. NO.
8 Hole double tee bracket	TB151

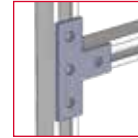

TEE BRACKET

DESCRIPTION	CAT. NO.
4 Hole flat tee bracket	TB152



CHANNEL SUPPORT BRACKET

DESCRIPTION	CAT. NO.
4 Hole corner channel support bracket	TB153

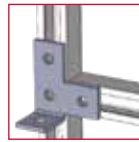

CORNER SUPPORT BRACKETS

DESCRIPTION	CAT. NO.
Left hand	TB154
Right hand	TB155



45° TEE BRACKET

DESCRIPTION	CAT. NO.
4 Hole 45° tee bracket	TB156



FLATE PLATE

DESCRIPTION	CAT. NO.
4 Way 4 hole flat plat	TB157

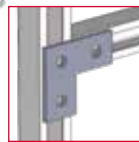

L BRACKET

DESCRIPTION	CAT. NO.
3 Hole flat bend bracket	TB161

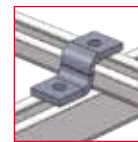

2 HOLE STEP-UP BRACKET

DESCRIPTION	CAT. NO.
2 Hole 20mm step up bracket	TB171



3 HOLE STEP-UP BRACKET

DESCRIPTION	CAT. NO.
3 Hole 40mm step up bracket	TB172



4 HOLE STEP-UP BRACKET

DESCRIPTION	CAT. NO.
4 Hole 80mm step up bracket	TB173

ACCESSORIES

Measurements:
Millimetres (mm)
unless stated
otherwise

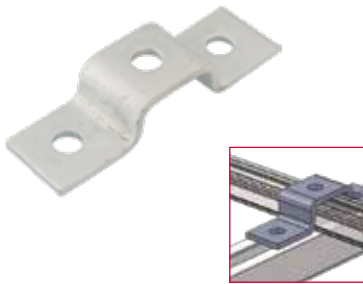

3 HOLE TOP HAT BRACKET

DESCRIPTION	CAT. NO.
3 Hole 20mm top hat	TB174

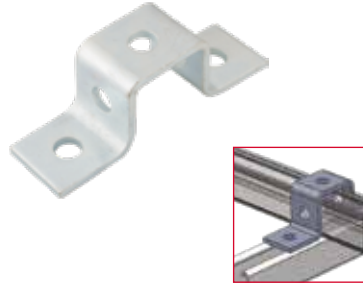

5 HOLE TOP HAT BRACKET

DESCRIPTION	CAT. NO.
5 Hole 40mm top hat	TB175

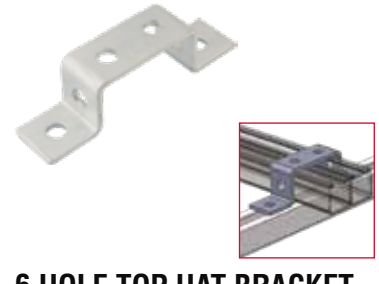

6 HOLE TOP HAT BRACKET

DESCRIPTION	CAT. NO.
6 Hole 80mm double top hat bracket	TB177

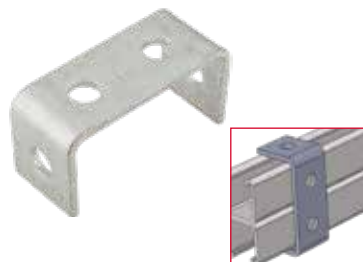

'U' BRACKET

DESCRIPTION	CAT. NO.
4 Hole 'U' double bracket	TB178

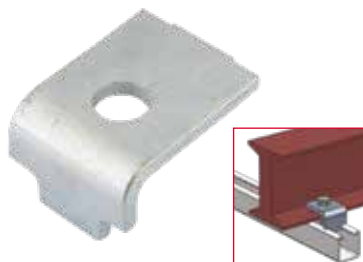

GIRDER CLAMP

DESCRIPTION	CAT. NO.
1 Hole girder clamp	TB251

Used with channel nut, not included.

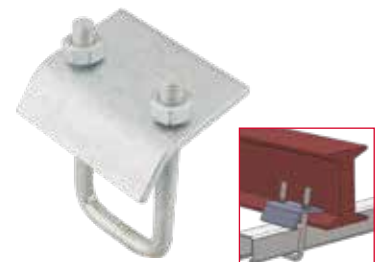

'U' BOLT

DESCRIPTION	CAT. NO.
40mm 'U' bolt	TB252-41

Suitable for: 21 x 41 & 41 x 41.



GIRDER CLAMP

DESCRIPTION	CAT. NO.
2 Hole girder clamp	TB253

Used with channel nut, not included.
Cone pointed screws (TF050) supplied.



GIRDER CLAMP

DESCRIPTION	CAT. NO.
'U' shape girder clamp	TB254

Cone pointed screws (TF050) supplied.



GIRDER CLAMP

DESCRIPTION	CAT. NO.
'U' shape girder clamp	TB255

Cone pointed screws (TF050) supplied.



WINDOW HOLE CLAMPS

DESCRIPTION	CAT. NO.
21mm Hole clamp	TB256-21
41mm Hole clamp	TB256-41

Cone pointed screws (TF050) supplied.



INTERNAL BEAM CLAMPS

DESCRIPTION	CAT. NO.
Internal beam clamp	TB257

Cone pointed screws (TF050) supplied.



BASE PLATE BRACKET

DESCRIPTION	CAT. NO.
Single	TB211-1



BASE PLATE BRACKET

DESCRIPTION	CAT. NO.
Corner	TB211-2



BASE PLATE BRACKET

DESCRIPTION	CAT. NO.
Double	TB212



BASE PLATE BRACKET

DESCRIPTION	CAT. NO.
Gusset	TB213

Measurements:
Millimetres (mm)
unless stated
otherwise



CANTILEVER ARMS

TC103-15

DESCRIPTION	CAT. NO.
150mm Long arm - plain	TC103-15
300mm Long arm - plain	TC103-30
450mm Long arm - plain	TC103-45
600mm Long arm - plain	TC103-60
750mm Long arm - plain	TC103-75



COVER

DESCRIPTION	COLOUR	CAT. NO.
3m Plastic cover	White	TA103-P
3m Plastic cover	Grey	TA103-G
3m Plastic cover	Black	TA103-B

Note: TA103-* will not fit light duty strut. Strut sold separately.



ROD END CAPS

TA008B TA010W

DESCRIPTION	COLOUR	CAT. NO.
M8 Rod end cap	White	TA008W
M8 Rod end cap	Black	TA008B
M10 Rod end cap	White	TA010W
M10 Rod end cap	Black	TA010B

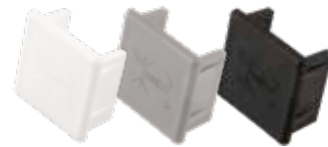

END CAPS

DESCRIPTION	COLOUR	CAT. NO.
21mm End cap	White	TA102
41mm End cap	White	TA101
21mm End cap	Grey	TA102G
41mm End cap	Grey	TA101G
21mm End cap	Black	TA102B
41mm End cap	Black	TA101B

CHANNEL NUTS



PLAIN

TN10P

CAT. NO.	SIZE
TN6P	M6
TN8P	M8
TN10P	M10
TN12P	M12



SHORT SPRINGS

TN10SS

CAT. NO.	SIZE
TN6SS	M6
TN8SS	M8
TN10SS	M10
TN12SS	M12



LONG SPRINGS

TN10LS

CAT. NO.	SIZE
TN6LS	M6
TN8LS	M8
TN10LS	M10
TN12LS	M12

FIXINGS

Measurements:
Millimetres (mm)
unless stated
otherwise



TF071

CAT. NO.	SIZE
TF068	M6
TF069	M8
TF070	M10
TF071	M12

Pack Quantity: 100 per pack.



TF030

FLAT WASHERS

DESCRIPTION	CAT. NO.
M6	TF030
M8	TF031
M10	TF032
M12	TF033

Pack Quantity: 100 per pack.



TF037

SHAKE PROOF WASHERS

DESCRIPTION	CAT. NO.
M6	TF034
M8	TF035
M10	TF036
M12	TF037

Pack Quantity: 100 per pack.



TF041

PENNY WASHERS

DESCRIPTION	CAT. NO.	DESCRIPTION	CAT. NO.
M6 x 25mm	TF038	M6 x 32mm	TF042
M8 x 25mm	TF039	M8 x 32mm	TF043
M10 x 25mm	TF040	M10 x 32mm	TF044
M12 x 25mm	TF041	M12 x 32mm	TF045

Pack Quantity: 100 per pack.



TF025

ROOFING NUTS & BOLTS

CAT. NO.	SIZE
TF025	M6 x 12mm
TF026	M6 x 16mm
TF027	M6 x 20mm
TF028	M6 x 25mm
TF029	M6 x 30mm

Pack Quantity: 200 per pack.



CONE SET SCREWS

CAT. NO.	SIZE
TF050	M10 x 40

Pack Quantity: 100 per pack.



TF002

M6 SET SCREW BOLTS (HIGH TENSILE)

DESCRIPTION	CAT. NO.
M6 x 20mm	TF001
M6 x 25mm	TF002
M6 x 30mm	TF003
M6 x 35mm	TF004
M6 x 40mm	TF005

Pack Quantity: 100 per pack.



TF008

M8 SET SCREW BOLTS (HIGH TENSILE)

DESCRIPTION	CAT. NO.
M8 x 20mm	TF006
M8 x 25mm	TF007
M8 x 30mm	TF008
M8 x 35mm	TF009
M8 x 40mm	TF010

Pack Quantity: 100 per pack.



TF013

M10 SET SCREW BOLTS (HIGH TENSILE)

DESCRIPTION	CAT. NO.
M10 x 20mm	TF011
M10 x 25mm	TF012
M10 x 30mm	TF013
M10 x 35mm	TF014
M10 x 40mm	TF015

Pack Quantity: 100 per pack.



TF019

M12 SET SCREW BOLTS (HIGH TENSILE)

DESCRIPTION	CAT. NO.
M12 x 20mm	TF016
M12 x 25mm	TF017
M12 x 30mm	TF018
M12 x 35mm	TF019
M12 x 40mm	TF020

Pack Quantity: 100 per pack.



TF048

HEXAGONAL NUTS

CAT. NO.	SIZE	CAT. NO.	SIZE
TF046	M6	TF048	M10
TF047	M8	TF049	M12

Pack Quantity: 100 per pack.



TF058

STUD CONNECTOR

CAT. NO.	SIZE	CAT. NO.	SIZE
TF055	M6	TF057	M10
TF056	M8	TF058	M12

Pack Quantity: 100 per pack.



TF061

WEDGE NUT

CAT. NO.	SIZE	CAT. NO.	SIZE
TF059	M6	TF061	M10
TF060	M8	TF062	M12

Pack Quantity: 100 per pack.

TRUNKING SIZE (mm)

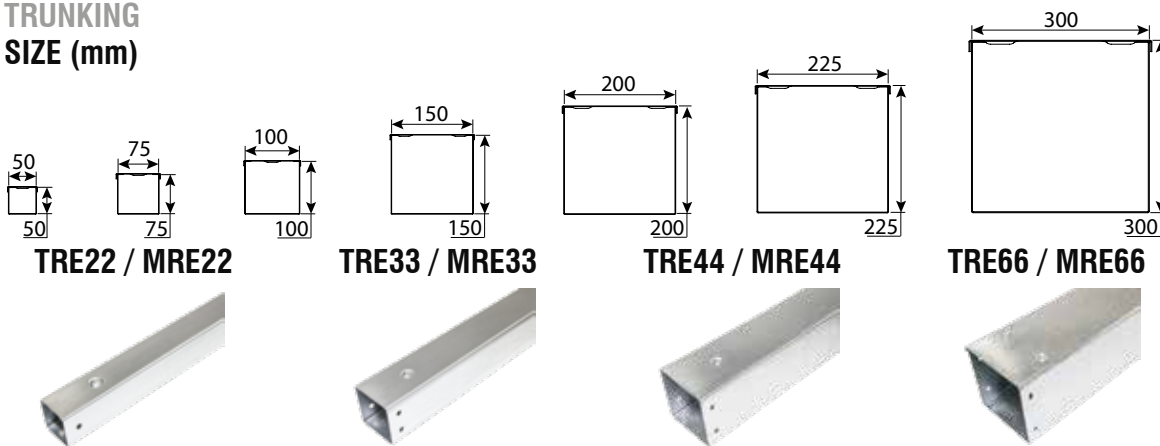

IMPORTANT: Cable trunking is designed such that the main body carries the weight of the cables, Trunking should NOT be installed in any way that causes the lid to carry the cable weight.

TRUNKING SIZE

SIZE OF TRUNKING CAT. NO.	NOMINAL CONDUCTOR SIZE											
	1.0	1.5	2.5	4.0	6.0	10.0	16.0	25.0	35.0	50.0	70.0	95.0
50 x 50	138	123	85	67	52	33	24	16	12	9	7	5
75 x 50	208	185	128	101	79	51	37	24	18	13	10	7
75 x 75	312	273	191	152	118	76	55	37	28	20	16	11
100 x 50	277	247	170	135	95	67	49	39	25	18	14	10
100 x 75	416	370	256	203	158	101	74	49	37	27	21	15
100 x 100	555	494	350	271	211	135	98	66	50	37	28	21
150 x 75	624	556	382	304	237	152	111	74	56	41	32	23
150 x 100	833	741	510	406	316	203	148	99	75	55	42	31
150 x 150	1250	1112	766	609	475	305	222	148	112	83	64	47

LIGHTING TRUNKING

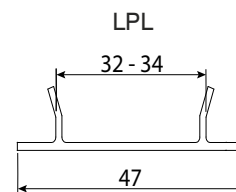
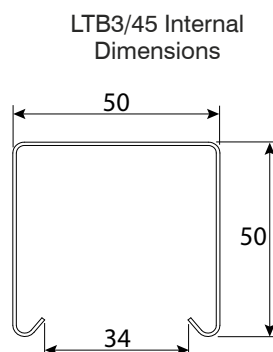

TRUNKING	SIZE SURFACE (mm)	NOMINAL CONDUCTOR SIZE										WEIGHT PER Kg/m
		1.0	1.5	2.5	4.0	6.0	10.0	16.0	25.0			
LTB3/45	50 x 50	138	123	98	67	52	33	24	16	14.5		

Support centres maximum 3 metre
Trunking Lid supplied in 2 metre lengths as standard and are manufactured to fit LTB trunking body.

CABLE TRAY SIZE (mm)

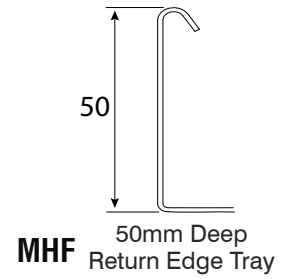
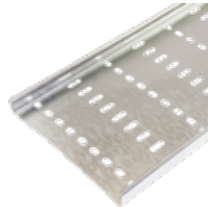
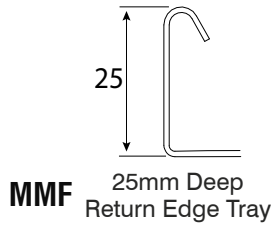
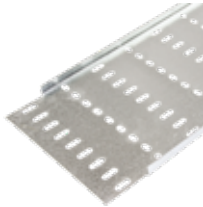
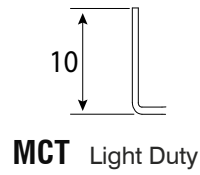

HOLE PATTERN

Hole pattern designed to provide maximum flexibility for positioning cable ties etc.

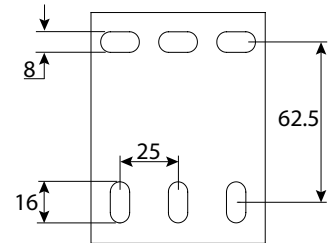

COUPLERS FOR RETURN EDGE TRAY

Snap-on couplers are fitted outside tray and are supplied as pairs without fixings. Multiple fixings positions including M6 and slotted.

Return flanged tray couplers do not require the tray to be drilled, even when the tray has been cut.

Assembly nuts and bolts are supplied separately (Cat. No. TF025).

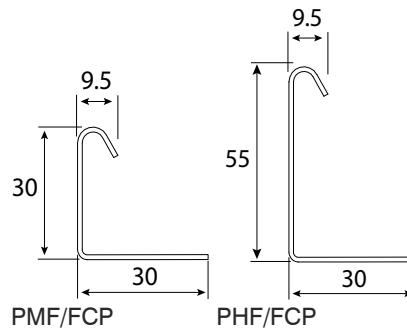

Tray is transparent for illustrative purposes



GENERAL CABLE TRAY DATA

The Tamlex range of PCT cable tray can be site fabricated to produce flat bends, tees and fourway sections using roofing nuts & bolts.

LOAD TEST DATA EXAMPLE

Tamlex PMF 100 Medium Duty Tray

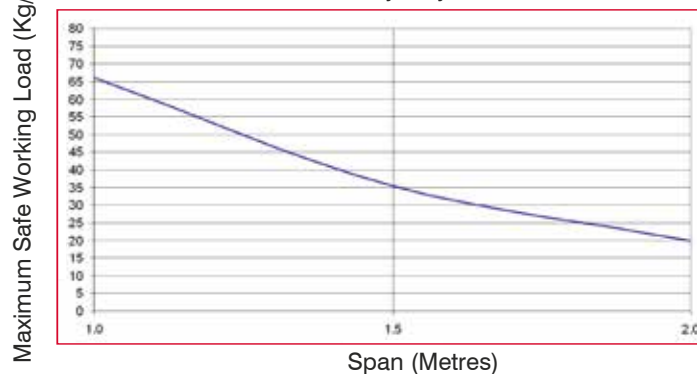

BASKET TRAY

TRUNKING	MINIMUM WORKING TEMPERATURE	MAXIMUM WORKING TEMPERATURE	ACCORDING TO STANDARD
60mm FastConnect Basket Tray	-40°C	+150°C	BS EN 61537

MATERIAL

Electrogalvanised (ELECTROZINC/EZ)

A steel base coated with a zinc layer by electrolysis, by means of submerging the lengths in a bath composed of a zinc solution, in accordance with BS EN ISO 2081. Depending on the type of zinc layer, it will have a different degree of protection on the steel, avoiding corrosion and enhancing the visual appearance of the length. This treatment is carried out once the length has been welded.

The IEC 61537 Standard classifies the degree of resistance to corrosion of the system's components depending on the steel's electrolytic covering, belonging to Class 1 those with a minimum thickness of 5µm and to Class 2 those of 12µm. Tamlex uses **Class 6** as its standard material for its basket tray in order to guarantee the quality of its products against corrosion. This treatment is used in dry environments free of pollutants.

SUPPORT BRACKET

The distance between supports is of 1.2m and the maximum load is of 10Kg/m.

LIGHT DUTY SUPPORT BRACKET

The distance between supports is of 1.2m and the maximum load is of 2Kg/m.

EARTH BONDING

For earth bonding requirements please refer to the current Wiring Regulations BS7671 and all current amendments.

NEW INNOVATIVE PLATED FINISH OFFERING SUPERIOR PROTECTION AGAINST CORROSION

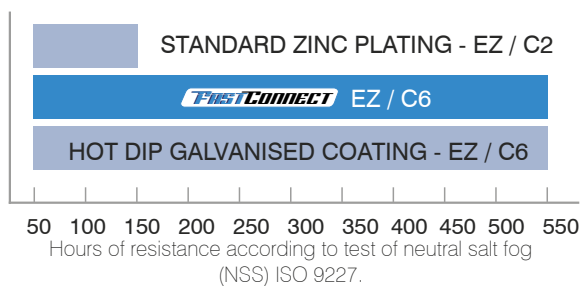

HIGHER CORROSION RESISTANCE

550 hours of resistance according to test of neutral salt fog (NSS) ISO 9227.

HIGHER CORROSION RATING ACCORDING TO PRODUCT STANDARD IEC 61537

Class 6.

GREENER COATING

The final solution requires less chemicals, with lower levels of discharge of metal in the wastewater. Reduces costs and environmental impact.

ALLOWABLE WORKING LOAD AWL (N/m)

The allowable working load (AWL) is the maximum load which can be applied during normal use, without danger. Therefore, the workload shall always be less than the AWL.

The AWL of our products are calculated in accordance with BE EN 61537.

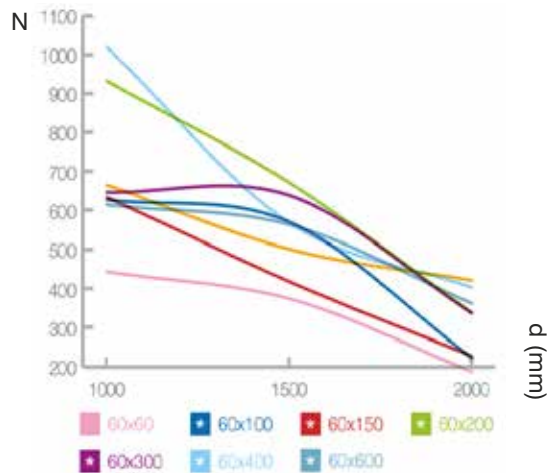

AWL = (Newtons/m) ; d = distance between supports (mm)
1 Newton = 0.102 kg.

Tamlex presents its new anti-corrosion coating applied to the basket tray. After a long period of research and development with specialists in the field, the result is a superior galvanic coating. **Iridescent**, fluoride-free with much higher quality to the previous electrozinc and dichromate electro zinc.

- Pre-Fabricated Bends
- Tool Free Installation
- FastConnect Coupler Included
- Electrical Continuity Compliant to EN 61537
- Coupler Can Be Easily Removed and Repositioned
- Safety Edge To Avoid Damage To Cables

STRUT FRAMEWORK SYSTEM

Material: 2.5mm thick cold rolled steel (also available in 1.5mm)

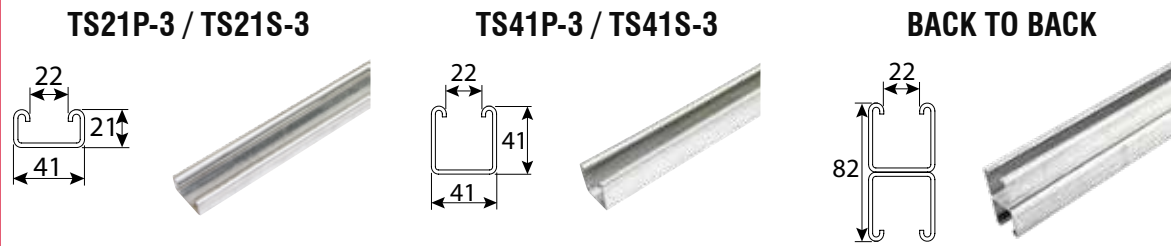

STRUT FRAMEWORK SYSTEM

Material: 2.5mm thick cold rolled steel (also available in 1.5mm)

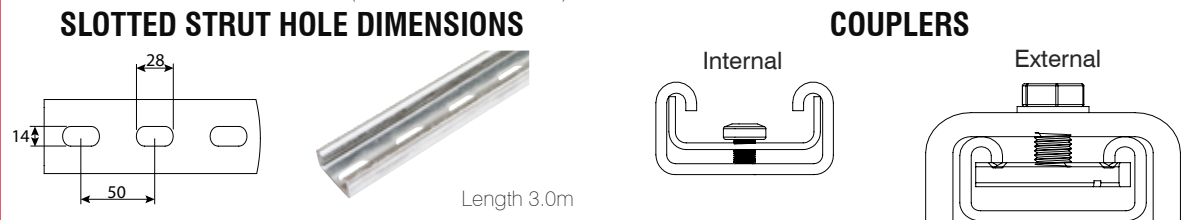

SERVICE BOXES COMPARTMENT OPTIONS

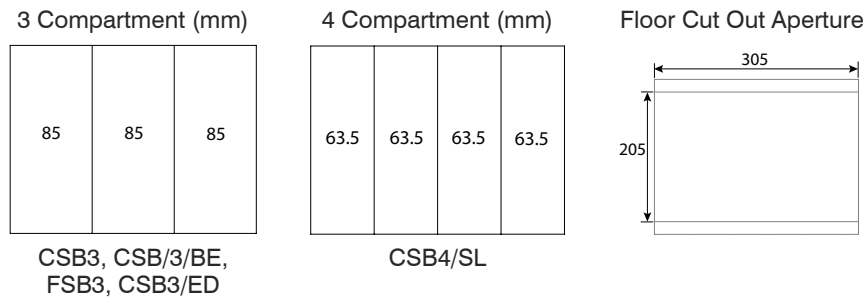

IMPORTANT: PLEASE NOTE - Service boxes are designed for use in office type environments and should not be installed in main walkways, corridors, gangways or in contact with wheeled traffic.

PLATE DIMENSIONS

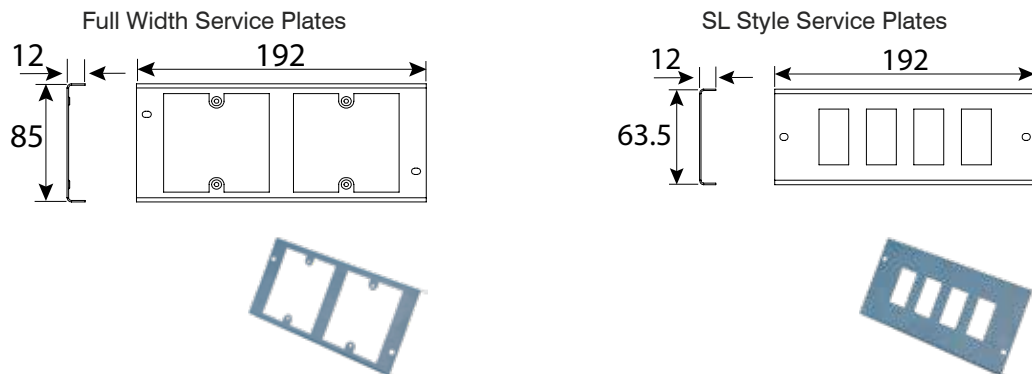

MODULAR FLUSH SCREED TRUNKING

Modular flush screed trunking must be fully supported across its complete width.
 Modular Flush Screed Cross Section Modular Flush Screed Service Box FSBM3

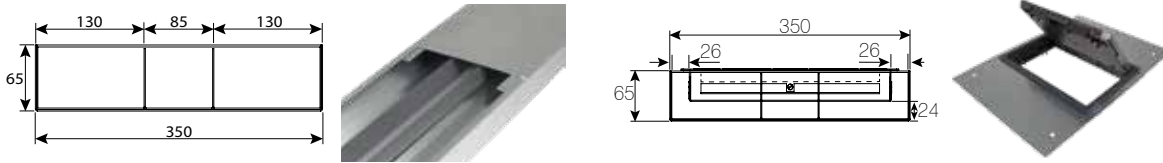

FLUSH SCREED TRUNKING

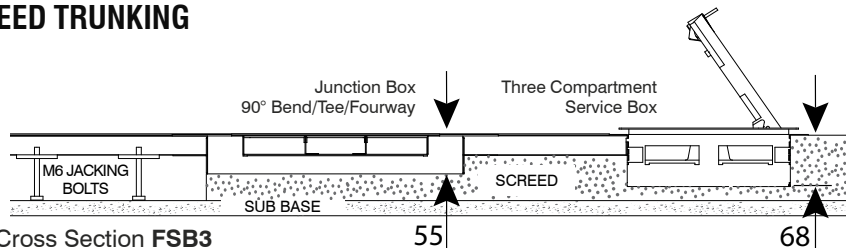

Flush Screed Cross Section FSB3

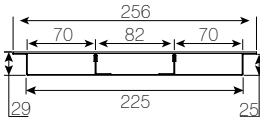

Screed trunking must be fully supported across its complete width. The minimum screed depth is 68 mm. Service boxes should be installed when the trunking is fitted.

Please see technical details for Service Boxes above.

MODULAR FLUSH SCREED TRUNKING

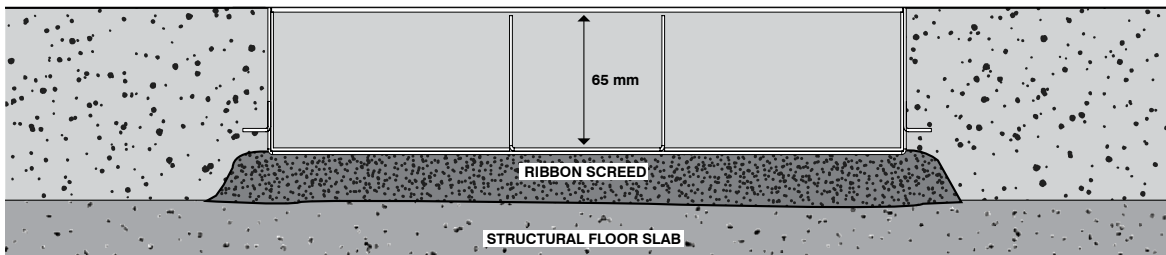

FLUSH SCREED TRUNKING

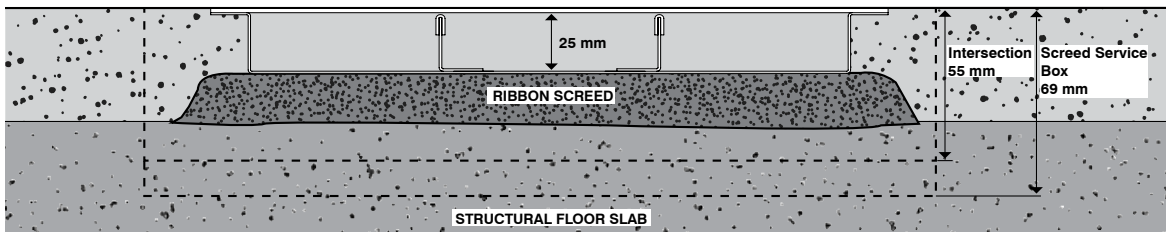

This innovative and customisable system can be installed in new developments or in an existing installation. Below are some of our installation guidelines that needs to be considered when using this system.

- 1. Access (Existing Installations Only).** Adequate space needs to be cut in the screed to allow access for trunking system and access for installation tools.
- 2. Solid Foundation.** Screed trunking must be installed on a solid foundation and completely supported by a screed ribbon approved by an consultant or architect.
- 3. Lids and Service Boxes.** The galvanised trunking lids and service boxes should be in position before the screed is poured to ensure the pressure of the screed does not distort the side walls of the trunking.
- 4. Levelling.** Once the trunking is levelled and before coupling together, the screed ribbon/bedding should be packed under the trunking to remove the possibility of any voids which could create soft spots in the trunking system.
- 5. Finishing.** Take care when pouring the screed. The screed should be compacted to provide a fixed support for the trunking system and its contents. Ensure the screed is smoothly finished to the trunking lid to prevent any lines showing on the final flooring finish.

Tamlex
01952 586 689
sales@tamlex.co.uk
www.tamlex.co.uk

Harcourt
Halesfield 15
Telford
Shropshire
TF7 4ER



The content of this catalogue is for information only. The manufacturer reserves the right to alter design or specification without prior notice. Colours are reproduced as accurately as photographic and printing processes allow and may not exactly match the actual products.

Issue 2.3